



NEELKANTH

STAINLESS STEEL SINKS



AN ISO 9001 : 2008
CERTIFIED COMPANY

Elegance meets Functionality

STAINLESS STEEL AISI 304-18/8



Washing vegetables, pulses etc., then preparing them for cooking like cutting, peeling, mixing and also cleaning of the utensils all happen in and around kitchen sink. Almost 60% of your time spent is with your kitchen sink, then why just have a sink when you can choose the right kind which suits your needs? For a basic need, or you being a culinary specialist, Neelkanth has made a unique kitchen sink for all, with a choice of either crisp lines or smooth curves.

NEELKANTH makes a sink without overpowering the senses, reflecting its passion for bringing inspired beauty in your kitchen. When it comes to kitchen sinks, Neelkanth's superbly engineered kitchen sinks are a good example because they offer endless possibilities. They are India's leading stainless steel kitchen sink specialist, with 6 designs, 7 variants, in all about 100 kitchen sinks to choose from.

NEELKANTH is the only truly Indian premium brand of domestic and commercial kitchen sinks. A continuous stream of innovations is the foundation of Neelkanth's success. Enduring success is only possible when consistent efforts are made to remain 'forever better'. In terms of quality, Neelkanth kitchen sinks were and are considerably better than those of the competition, otherwise they would not have been able to compete successfully on such a fiercely competitive market.

NEELKANTH kitchen sinks: A Winning Combination

We can only brag so much about our products, so this will make things a bit easier: a leading independent testing agency (ISI) has all granted Neelkanth its mark on its sinks. Neelkanth's newest three stars are part of the largest kitchen

sink portfolio in the country. They are:-

- 1. The STATELINE**
- 2. The D-LINE**
- 3. TOPMOUNT**

The current lineup of stainless steel kitchen sink represents a substantial commitment from product development and manufacturing standpoint that reflects our goal of becoming the industry leader, and we are excited to say that we are delivering on that goal.

Green is greater than Neelkanth

People are increasingly showing their commitment to sustainable living through the choices they make while they buy products. By default our basic raw material is stainless steel and it is bio degradable. Our goal is to continue making products that are strong while used in kitchen and very gentle to our earth planet.

NEELKANTH has been providing real innovations in kitchen sinks for more than 30 years. The iconic line of its stainless steel kitchen sinks remains committed to empowering culinary

enthusiasts to be their best through continuous innovation breakthroughs. While you flip through this book you will learn about our heritage-product feature and will surely find the right kitchen sink.

About us

For more than 3 Decades, **NEELKANTH** Brand is an established market leader in stainless steel Kitchen Sinks.

The company aims to provide hygienic, practical and superior kitchen sinks to meet every users specific requirements by offering more than 100 designs.

NEELKANTH products are largely used in domestic kitchens and also in virtually every economic sector. Our clients include private and state owned enterprises, health services, leisure, education, culture, science, administration and commerce. From end-user individuals to corporate multinationals, employing world-renowned architects and designers are using/installing our sinks.

This has been made possible by the people behind this brand, who are working with one aim.

To make each and every product as prescribed by the management team we have adopted ISO 9001: 2008

compliant conditions in our modern workshops using highly efficient, state-of-the-art, automated manufacturing processes and finished by skilled craftsmen.

Our philosophy 'What we say is what you get' has been supported by ISI marks and the large customer base in the world.

Our global style sinks are made of AISI 304 (18/8) Stainless Steel and available in 6 different designs - In-sets, Under mount, State-Line, D-Line (Unconventional), Sink Systems and Premium Sink Series.

We have over 100 models, which come in various combination of Bowls and Drain Boards. Each sink design is made to enhance the over all graceful look of user's modern kitchen and keep it in league with the latest and the best international designs which you shall see in the following pages.

NEELKANTH sinks are distributed in India through a strong network of more than 500 Distributors and Dealers. We are also suppliers as OEM to many major brands in India.

Heritage

Decade Timeline

1980

- 1982** : Sink Business Started with one model.
- 1984** : The market covered with 10 models and the Widest network across the country.
- 1986** : Introduced Extra Deep sink up to 10"
- 1988** : Introduced for the first time in the world 10" deep bowl with drain board without welding joint.
- 1989** : Introduced India's first double bowl sinks with Seamless welding Joint.

2000

- 2001** : Registered with almost all Govt. Organizations & leading developers as approved supplier around the country.
- 2006** : Enhanced the production capacity and started Supplies as OEM to leading Sanitaryware Brands.
- 2008** : Introduced unconventional Designs to meet the Rising demands of Modular Kitchen Business.

1990

- 1990** : Entered into Export market.
- 1992** : Got first ISI Certification in sinks product category for quality standards.
- 1994** : Developed Nested sinks to increase the Storage capacity to meet the rising demand of International buyer.
- 1996** : Developed the In-set installation system of sinks to give leakage proof washing area in kitchens.
- 1997** : Introduced under mount Installation system and 3 way matt finish
- 1999** : Introduced the sinks with systems incorporated with facilities: sliding garbage bin, chopping board and separate sink bowl for cutlery.

2010

- 2010** : Introduced the first country made hand crafted "ZERO" radius sinks and were the only sink supplier for Prestigious Common Wealth Games village.
- 2011** : **Tropical Industries International Pvt. Ltd.** is a subsidiary of **Tropical General Investment (www.clicktgi.net)**, which is a \$ 500 million Dutch company. Takes over Neelkanth Brand. Introduced Designer Washbasins.
- 2012** : More then 100 Models, new manufacturing plant facility, 3 new finishes, Asian, American, European installation designs, ISI, ISO, CSA certification and all our products were made available all over the country with the widest Network of Dealers/ Distributors.

The distinctive, inimitable character of the **NEELKANTH** sinks never fails to catch the expert eye of people with taste. Sinks are often unique, surprising in their simplicity and beauty, and unostentatious about their true worth, almost as if they long to be result for the few who can recognize and appreciate them. The classical rigor and the strong modern feel that inspire **NEELKANTH**'s work, make them timeless and beyond transient trends. Aesthetics and function intermingle and overlap without limits. In harmony with philosophy according to which one must only strive for the best, the expert craftsmen at **NEELKANTH** confer that special touch, which no machine could ever offer.

Sink Combinations

NEELKANTH sinks are made in various bowl & drain board combination to suit every individuals requirement. More than 100 such combination are available in various shapes & sizes.

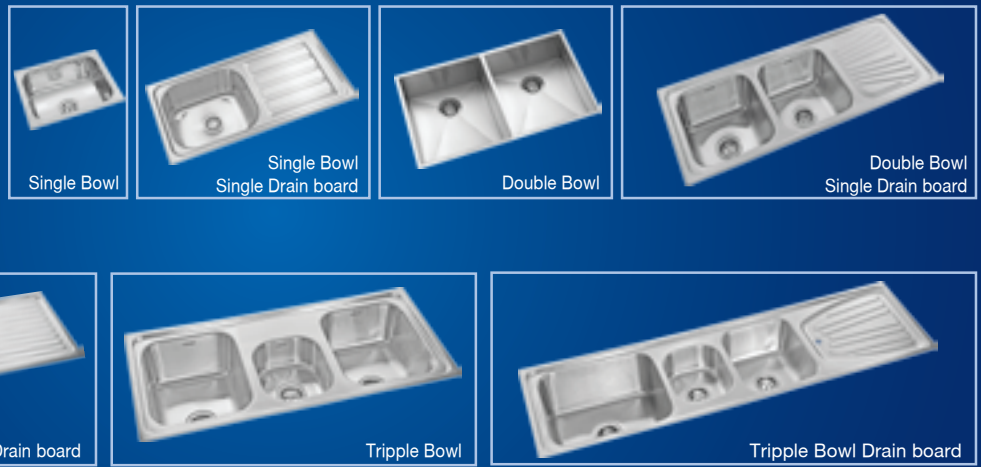

Drainers

Designer / Double press / Drip tray with In-build strainer / sleek-medium-broad ribs are various design of drain boards which have user benefits as well as give good aesthetic looks & rapid water flow towards sink bowl.



Bowl Shapes



Bowl shapes are designed to compliment the over all look of the kitchen. One has to choose according to his need & like.

Profile

All the installation profiles are designed keeping in mind the modular kitchen concept (marble / concrete / wooden / Korean & metal counter tops). The new under mount / inset installations has unique feature to save dripage & leakage in your kitchen.

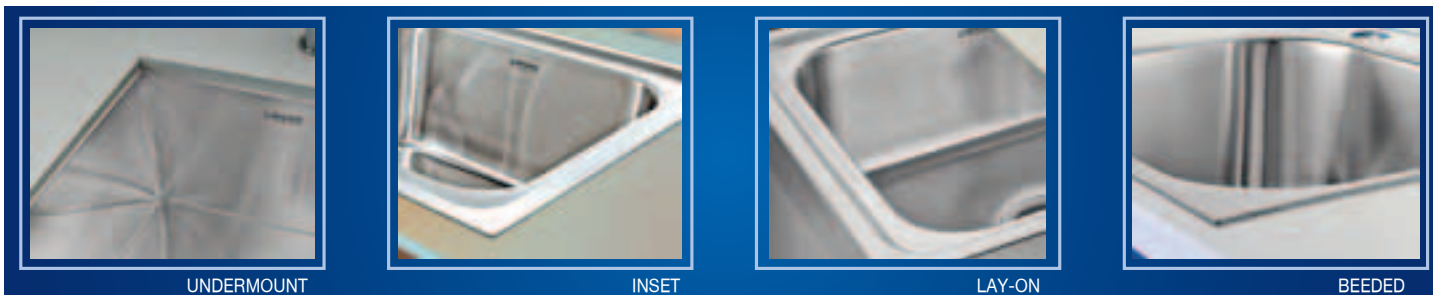

Bowl Depths

NEELKANTH sinks come in various bowl depth - 6 inches to 10 inches. Users can choose as per their needs, moderate/domestic user use shallow depths where as commercial applications need deeper bowl to facilitate large utensil cleaning. Bowl volume varies depending upon its depth between 15-80 litres.



Finish

NEELKANTH offers three different finishes.

- 1. High Gloss:** This finish is famous for its lustre & mirror effects. This finish is chosen & liked by millions of users.
- 2. Brush Finish:** **NEELKANTH** is world known for its three way matt finish which is rarely available in the world.
- 3. Linen Finish:** This raised texture finish which gives mixed look & feel of silver tone. Prevent the sink from scratches.



High Gloss Mirror



American Brush Finish



Scratch Resistant Linen Finish

Sound Dampeners

Selective models are completely under coated bowls with special rubber pads which make the sink less noisy while in use.



Grade/Gauge

Made from
AISI 304 (18/8)
Grade Stainless Steel
in 1 & 1.2 mm



Certification

To further our claims of quality consistency and to make sure all our products are manufactured under strict measure set by our management, we have adopted ISO 9001:2008 certifications. Our ISI marked products compliments our efforts in this direction.

INDIA'S FIRST ISI BRAND



Selective Models Only



AN ISO 9001 : 2008
CERTIFIED COMPANY

indian european american designs

In-Set Sinks



These sinks come in various Bowls, Drain board and Drip Tray combinations to suite individuals requirements. Resting on the kitchen counter top they look very elegant. These sinks come with complete installation Hardware Kit and template.

Features

- Strainer
- Under Coated
- Finish - Linen & Brush

Under-Mount Sinks

These sink series are the most stylish and very popular in the US. As the name suggest these sinks are installed from under the counter where the counter top has been cut-through with the help of template given along the sink. A set of complete Hardware Kit is in the box. These comes in a various combination of bowls and sizes to suite each individuals requirement.



Features

- Strainer
- Under Coated
- Finish - Linen & Brush

State Line Sinks

State Line Sinks are Handcrafted Sink. The latest in Designer's series the Line Shape base gives it a very sleek and modern look. The Drain board comes with strainer. These can be installed either under the counter or as Drop-in.

Features

- Strainer
- Finish - Brush



The Sinks with System

The most feature packed sink series, which have Large Bowls, Quarter Bowls, Cutlery Bowls, Drain board, Chopping Board and Garbage Bin, all these features in a very Compact size 48"x20", (5 models) and Junior Compact series in size 32"x20", (4 models).

A SUPER HIT model in today's shrinking kitchen space yet with all the features any housewife would love to have.

Features

- Strainer • Finish - Gloss & Matt
- With Accessories

D-Line Sinks



D-Line Sinks (Unconventional) sinks are in 'D' Shape. This unconventional shape leaves extra working space to the user than near the Faucet. These can be installed either under the counter or as Drop-in.

Features

- Strainer
- Finish - Brush

This series has the largest variety, from Single Bowl to Double Bowl with Cutlery Bowl and Drain board combinations. Bowl sizes are ranging from 11"x16" to 24"x18" and up to 6" to 10" depth. This series has sinks up to 6 feet long. Premium sinks are the most popular series.

They come in Beeded and Lay-on installations.

Features

- Strainer • Finish - High Gloss & Matt



Premium Sinks

Single Bowl

- Inset • Undermount • Lay-on / Beeded

The best example of engineering, the hand crafted sinks to give more straight edges & shape to give the user more space.



Single Bowl

• Inset • Undermount • Lay-on / Beeded

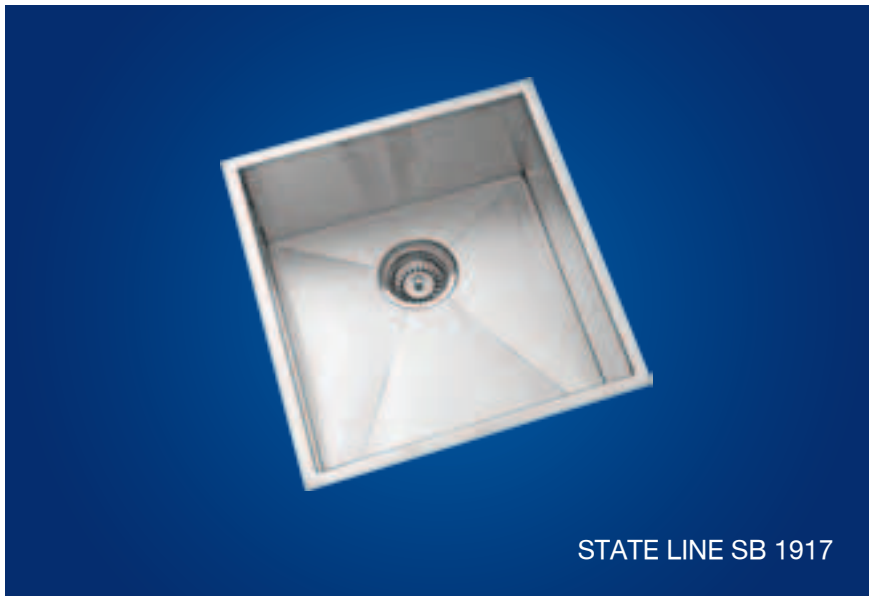

CODE : NK SB26 M

Specification

OVERALL SIZE:	FINISH:	THICKNESS:
19¼ x 17¼ inch 490 x 440 mm	Matt	1.2 mm
BOWL SIZE:	PROFILE:	
17½ x 15¼ x 8 inch 445 x 400 x 205 mm	Undermount	

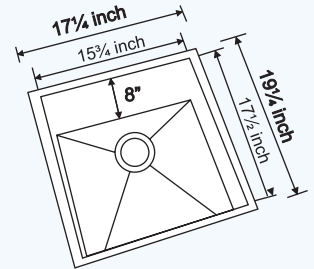

STATE LINE SB 1917

CODE : NK SB28 M

Specification

OVERALL SIZE:	FINISH:	THICKNESS:
24 x 18 inch 610 x 460 mm	Matt	1.2 mm
BOWL SIZE:	PROFILE:	
22 x 16 x 9 inch 555 x 405 x 230 mm	Undermount	

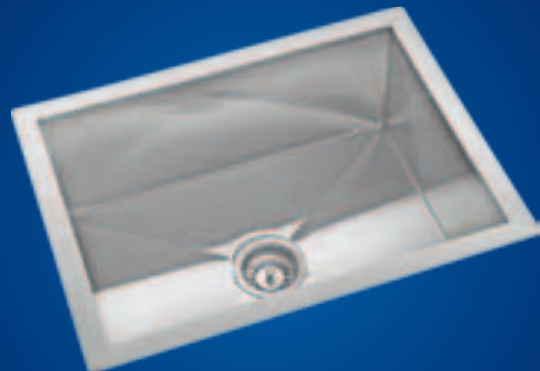
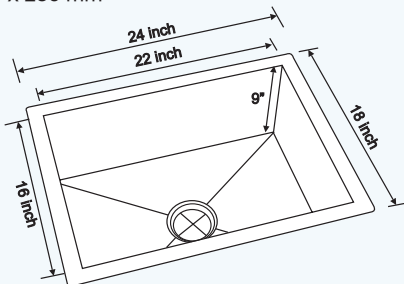

STATE LINE 2418

NEW



STATE LINE 3220 SB

CODE : NK SB29 M

Specification

OVERALL SIZE:	FINISH:	THICKNESS:
32 x 20 inch 810 x 510 mm	Matt	1.2 mm
BOWL SIZE:	PROFILE:	
30 x 18 x 9 inch 760 x 455 x 230 mm	Undermount	

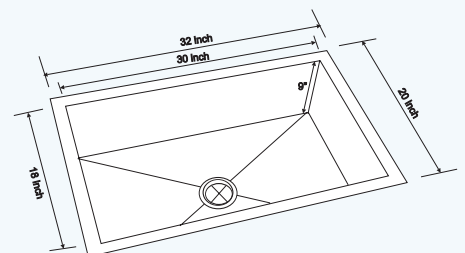

Single Bowl

- Inset • Undermount • Lay-on / Beeded

D- Line series offer an ergonomic design to give the user a pleasurable experience. This is the most unconventional shape available.

UNCONVENTIONAL



Single Bowl

• Inset • Undermount • Lay-on / Beeded



UNDERMOUNT 2019 D

CODE : NK SB12 M

Specification

OVERALL SIZE: 20 x 19½ inch 510 x 495 mm	FINISH: Matt
BOWL SIZE: 17¼ x 17¼ x 9 inch 450 x 450 x 230 mm	PROFILE: Undermount

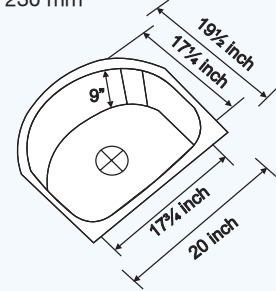

CODE : NK SB13 M

Specification

OVERALL SIZE: 23¼ x 21¼ inch 590 x 540 mm	FINISH: Matt
BOWL SIZE: 21 x 19 x 9 inch 535 x 480 x 230 mm	PROFILE: Undermount



UNDERMOUNT 2321 D



UNDERMOUNT NUH 1513

CODE : NK SB10 M

Specification

OVERALL SIZE: 14¾ x 12¾ inch 375 x 324 mm	FINISH: Matt
BOWL SIZE: 10½ x 12½ x 6 inch 270 x 315 x 150 mm	PROFILE: Undermount

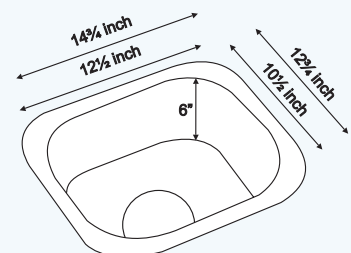

Single Bowl

- Inset • Undermount • Lay-on / Beeded

Small but more useful sink for cleaning your veggies & fruits near your cooktop.



• Inset • Undermount • Lay-on / Beeded



UNDERMOUNT NUH 1515

CODE : NK SB11 M

Specification

OVERALL SIZE:	FINISH:
Dia. 15 inch	Matt
Dia. 375 mm	
BOWL SIZE:	PROFILE:
12½ x Round 6 inch	Undermount
Dia. 320 x 150 mm	

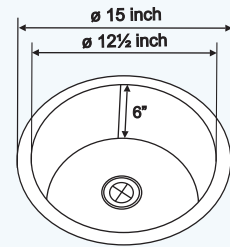

CODE : NK SB20 M

Specification

OVERALL SIZE:	FINISH:
18 x 16 inch	Matt
460 x 405 mm	
BOWL SIZE:	PROFILE:
16 x 14 x 9 inch	Undermount
400 x 350 x 230 mm	

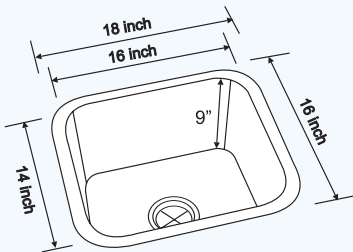

UNDERMOUNT NUH 1816

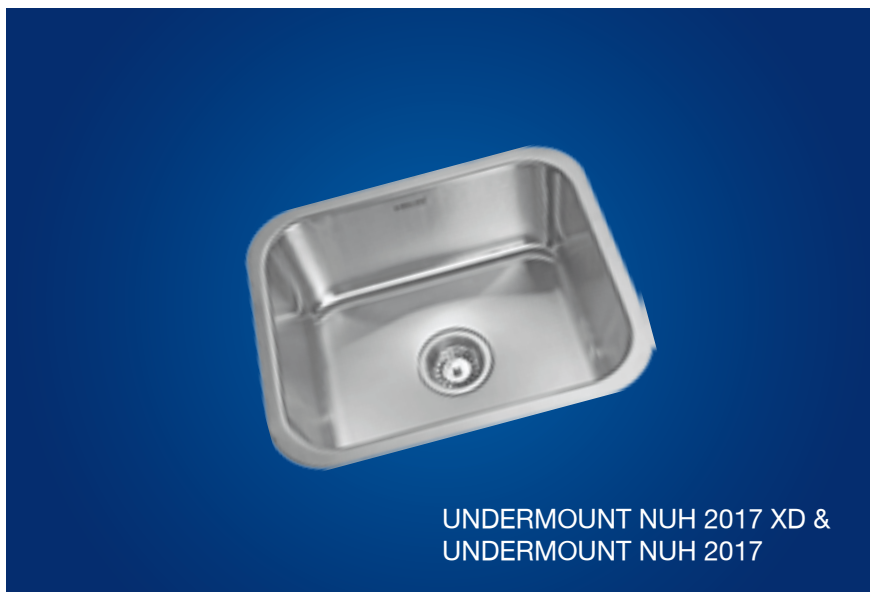

UNDERMOUNT NUH 2017 XD & UNDERMOUNT NUH 2017

CODE : NK SB8 M & NK SB9 M

Specification

OVERALL SIZE:	FINISH:
20 x 17 inch	Matt
510 x 430 mm	
BOWL SIZE:	PROFILE:
18 x 15 x 10/8 inch	Undermount
460 x 390 x 255/205 mm	

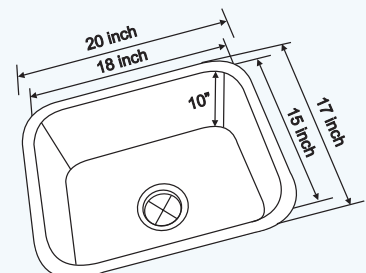

Single Bowl

• Inset • Undermount • Lay-on / Beeded



• Inset • Undermount • Lay-on / Beeded



CODE : NK SB7 M

Specification

OVERALL SIZE: 22 x 18 inch 560 x 460 mm	FINISH: Matt
BOWL SIZE: 20 x 16 x 10 inch 510 x 410 x 255 mm	PROFILE: Undermount

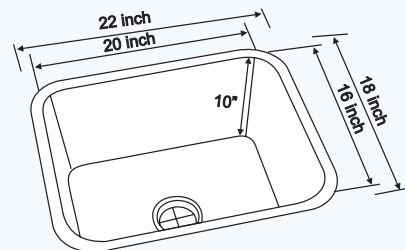

CODE : NK SB6 M

Specification

OVERALL SIZE: 23 x 19 inch 585 x 485 mm	FINISH: Matt
BOWL SIZE: 21 x 17 x 8 inch 520 x 420 x 205 mm	PROFILE: Undermount



NEW

UNDERMOUNT 3018

CODE : NK SB30 M

Specification

OVERALL SIZE: 30 x 18 inch 765 x 460 mm	FINISH: Matt
BOWL SIZE: 28 x 16 x 10 inch 712 x 410 x 255 mm	PROFILE: Undermount

Single Bowl

- Inset • Undermount • Lay-on / Beeded

Never feel messed up in your kitchen with a large gathering your hubby invited, if you have a large size sink in your kitchen.



Single Bowl (Topmount)

- Inset • Undermount • Lay-on / Beeded



Topmount 3120

CODE : NK SB31 Two Tone

Specification

OVERALL SIZE:	FINISH:
31 x 20 inch	Two Tone
788 x 510 mm	
BOWL SIZE:	PROFILE:
28 x 16 x 10 inch	Topmount
712 x 410 x 255 mm	

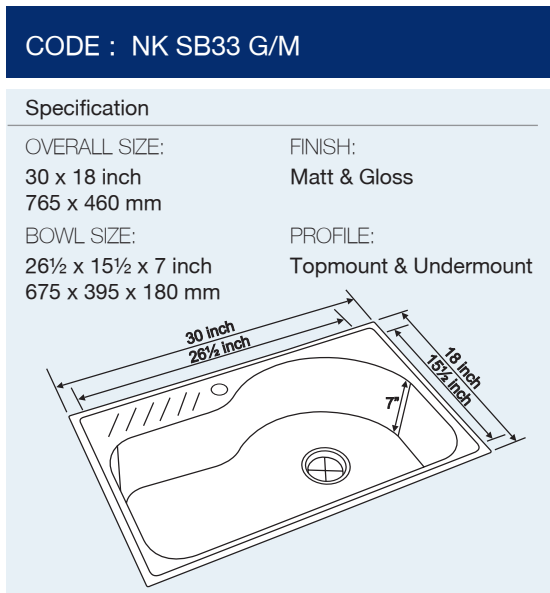
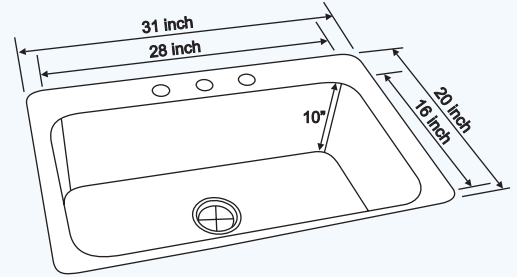

Topmount 3018



Topmount 2020

CODE : NK SB32 Two Tone

Specification

OVERALL SIZE:	FINISH:
20 x 20 inch	Two Tone
510 x 510 mm	
BOWL SIZE:	PROFILE:
18 x 15 x 10 inch	Topmount
460 x 385 x 255 mm	

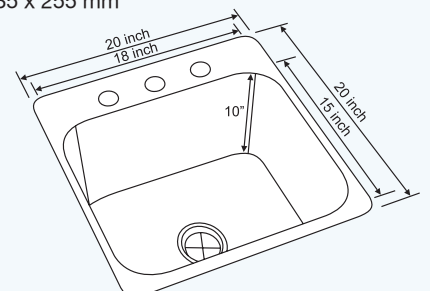

• Inset • Undermount • Lay-on / Beeded



MINI

CODE : NK SB25 G/M

Specification

OVERALL SIZE: 18 x 16 inch 460 x 405 mm	FINISH: Matt & Gloss
BOWL SIZE: 16 x 14 x 8 inch 400 x 350 x 205 mm	PROFILE: Lay-on & Beeded

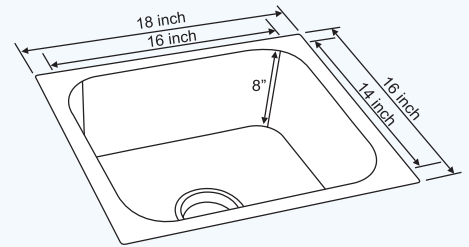

CODE : NK SB24 G/M

Specification

OVERALL SIZE: 20 x 17 inch 510 x 430 mm	FINISH: Matt & Gloss
BOWL SIZE: 18 x 15 x 8 inch 460 x 385 x 205 mm	PROFILE: Beeded

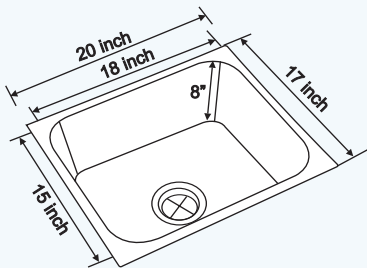

MONET



INSET LN 2018 SB (R)

CODE : NK SB5 L

Specification

OVERALL SIZE: 20 x 18 inch 510 x 460 mm	FINISH: Linen
BOWL SIZE: 16 x 14 x 8 inch 400 x 350 x 205 mm	PROFILE: Inset

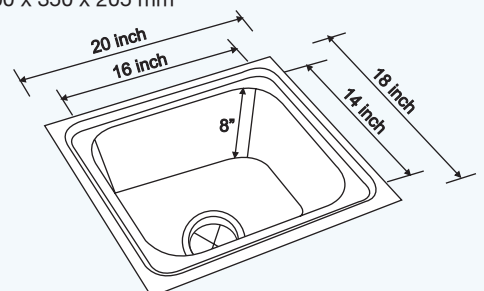

• Inset • Undermount • Lay-on / Beeded



JR. CELEBRITY

CODE : NK SB23 G/M

Specification

OVERALL SIZE: 21 x 18 inch 535 x 460 mm	FINISH: Matt & Gloss
BOWL SIZE: 18 x 15 x 8 inch 460 x 385 x 205 mm	PROFILE: Beeded

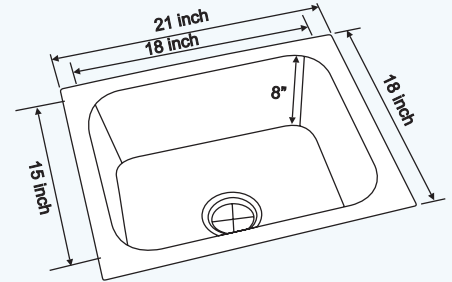

CODE : NK SB19 L

Specification

OVERALL SIZE: 24 x 18 inch 610 x 460 mm	FINISH: Linen
BOWL SIZE: 20 x 16 x 8 inch 510 x 410 x 205 mm	PROFILE: Lay-on

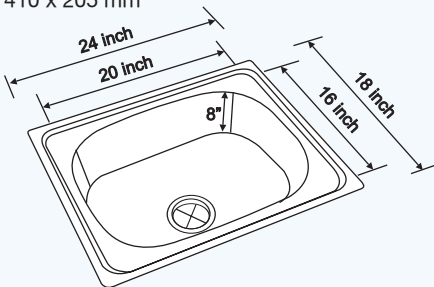

LAY-ON LN 2418 SB (R)



INDIA KING 10" & INDIA KING 8"

CODE : NK SB21 G/M & NK SB22 G/M

Specification

OVERALL SIZE: 24 x 18 inch 610 x 460 mm	FINISH: Matt & Gloss
BOWL SIZE: 20 x 16 x 10/8 inch 510 x 410 x 255/205 mm	PROFILE: Lay-on & Beeded

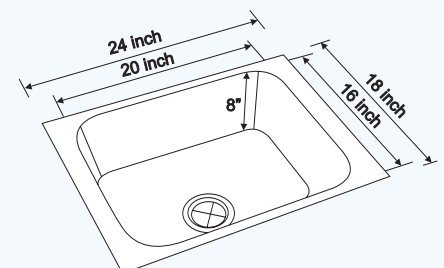

Single Bowl

- Inset • Undermount • Lay-on / Beeded

The best size to have in your kitchen, if you prefer single bowls, extra utility in small space.



CODE : NK SB27 G/M
MODEL : ARROW (SB 2418)



ARROW (SB 2418)

CODE : NK SB27 G/M

Specification

OVERALL SIZE: 24 x 18 inch 610 x 460 mm	FINISH: Matt & Gloss
BOWL SIZE: 22 x 16 x 9 inch 555 x 410 x 230 mm	PROFILE: Beeded

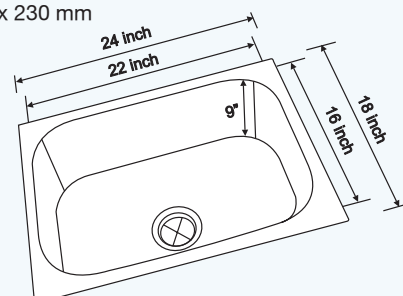

• Inset • Undermount • Lay-on / Beeded



CELEBRITY- 8"

CODE : NK SB18 G/M

Specification

OVERALL SIZE:	FINISH:
24 x 20 inch	Matt & Gloss
610 x 510 mm	
BOWL SIZE:	PROFILE:
21 x 17 x 8 inch	Lay-on & Beeded
535 x 435 x 205 mm	

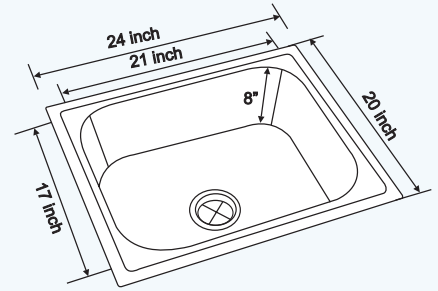

CODE : NK SB3 M & NK SB2 M

Specification

OVERALL SIZE:	FINISH:
24 x 20 inch	Matt
610 x 510 mm	
BOWL SIZE:	PROFILE:
20 x 16 x 10/8 inch	Inset
510 x 410 x 255/205 mm	

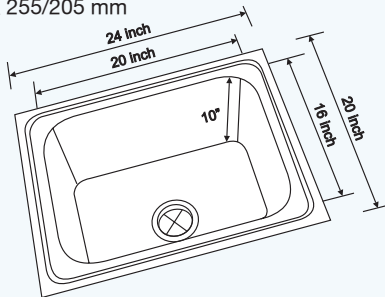

INSET 2420 SB XD & 2420 SB



INSET LN 2420 SB (R)

CODE : NK SB4 L

Specification

OVERALL SIZE:	FINISH:
24 x 20 inch	Linen
610 x 510 mm	
BOWL SIZE:	PROFILE:
20 x 16 x 8 inch	Inset
510 x 410 x 205 mm	

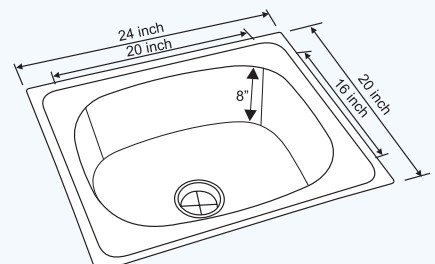

Single Bowl Single Drain Board

- Inset • Undermount • Lay-on / Beeded



CODE : NK SB16 G/M
MODEL : KITCHEN KING 8"



KITCHEN KING 8"

CODE : NK SB15 G/M & NK SB16 G/M

Specification

OVERALL SIZE: 26 x 20 inch 660 x 510 mm	FINISH: Matt & Gloss
BOWL SIZE: 24 x 18 x 10/8 inch 610 x 460 x 255/205 mm	PROFILE: Beeded

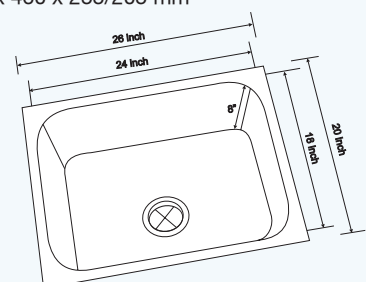

• Inset • Undermount • Lay-on / Beeded



CODE : NK SB1 M

Specification

OVERALL SIZE:	FINISH:
27 x 21 inch	Matt
690 x 535 mm	
BOWL SIZE:	PROFILE:
24 x 18 x 10 inch	Inset
610 x 460 x 255 mm	

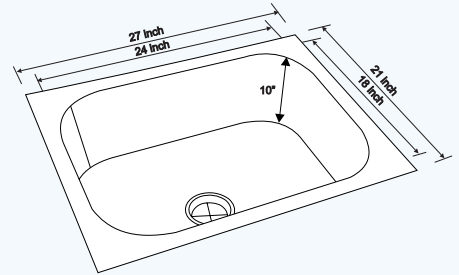

CODE : NK SB14 G/M

Specification

OVERALL SIZE:	FINISH:
27 x 24 inch	Matt & Gloss
690 x 610 mm	
BOWL SIZE:	PROFILE:
24 x 18 x 8 inch	Lay-on & Beeded
610 x 460 x 205 mm	

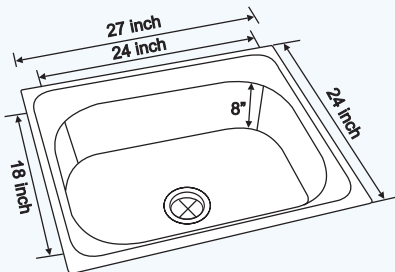

CODE : NK SB34 G/M

Specification

OVERALL SIZE:	FINISH:
30 x 18 inch	Matt & Gloss
765 x 460 mm	
BOWL SIZE:	PROFILE:
28 x 16 x 10 inch	Beeded
712 x 410 x 255 mm	

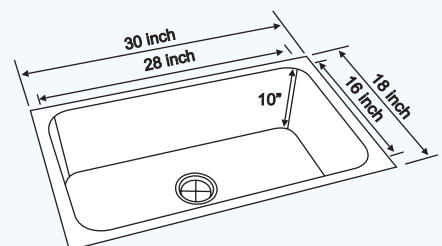

Single Bowl Single Drain Board

• Inset • Undermount • Lay-on / Beeded

Worry less working in rush hours with the drip tray sink. The double drain in sink & the drain board gives double utilization for cleaning utensils in the sink bowl and veggies / fruits on the drain boards without worrying about spillage.



Single Bowl Single Drain Board

• Inset • Undermount • Lay-on / Beeded

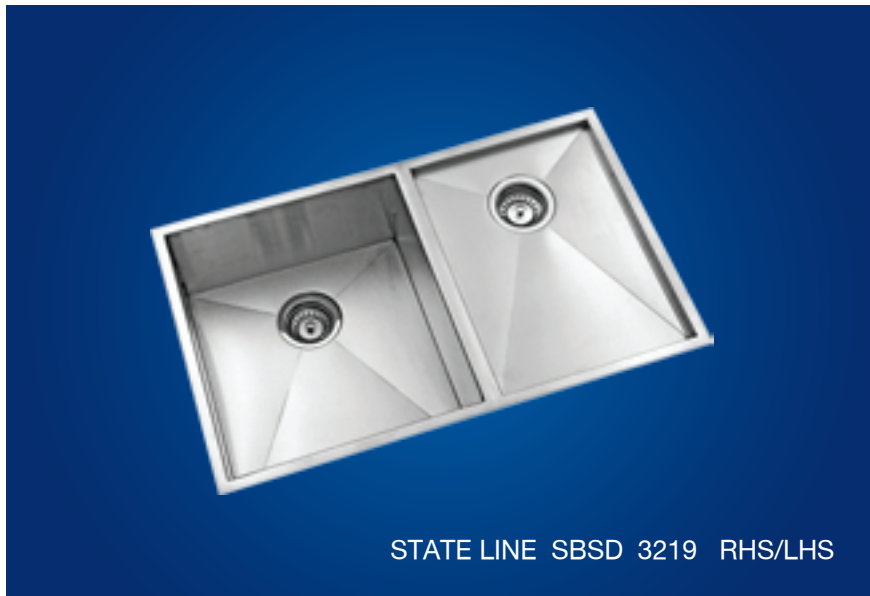

CODE : NK SBSD24 M

Specification

OVERALL SIZE: 31½ x 19¼ inch 800 x 490 mm	FINISH: Matt	THICKNESS: 1.2 mm
BOWL SIZE: 17½ x 16 x 8 inch 445 x 410 x 205 mm	PROFILE: Undermount	

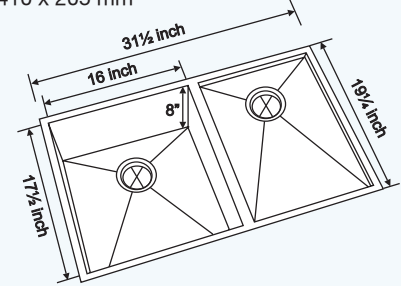

CODE : NK SBSD2 M

Specification

OVERALL SIZE: 40 x 20 inch 1015 x 510 mm	FINISH: Matt
BOWL SIZE: 14 x 16 x 8 inch 350 x 400 x 205 mm	PROFILE: Inset

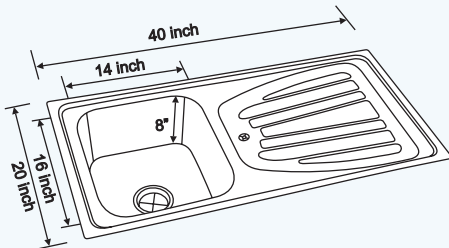

CODE : NK SBSD1 M

Specification

OVERALL SIZE: 45¼ x 20¼ inch 1156 x 515 mm	FINISH: Matt
BOWL SIZE: 20 x 16 x 8 inch 510 x 410 x 205 mm	PROFILE: Inset

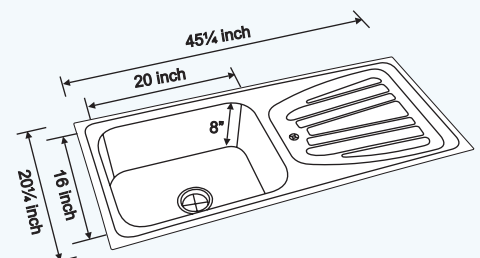

Single Bowl Single Drain Board

- Inset • Undermount • Lay-on / Beeded

The Nano size but with all features of a kitchen sink for small houses & apartment.



Single Bowl Single Drain Board

• Inset • Undermount • Lay-on / Beeded



MONTELO 3218 SBSD

CODE : NK SBSD23 G/M

Specification

OVERALL SIZE: 32 x 18 inch 810 x 455 mm	FINISH: Matt & Gloss
BOWL SIZE: 16 x 14 x 8 inch 400 x 350 x 205 mm	PROFILE: Lay-on, Beeded & Inset

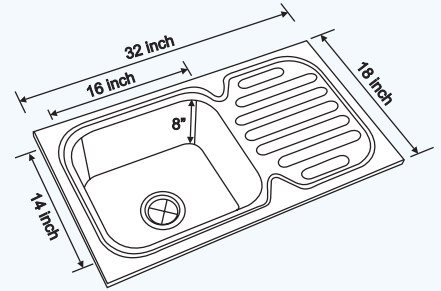

CODE : NK SBSD8 L

Specification

OVERALL SIZE: 32 x 20 inch 810 x 510 mm	FINISH: Linen
BOWL SIZE: 14 x 16 x 7 inch 350 x 400 x 180 mm	PROFILE: Inset

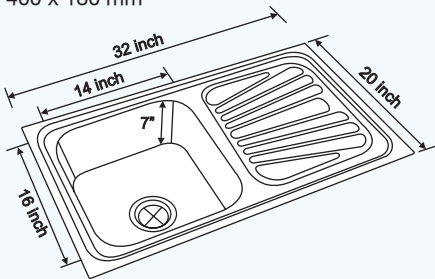

INSET LN 3220 SBSD (R)



INSET 3220 SBSD (R)

CODE : NK SBSD6 M

Specification

OVERALL SIZE: 32 x 20 inch 810 x 510 mm	FINISH: Matt
BOWL SIZE: 14 x 16 x 8 inch 350 x 400 x 205 mm	PROFILE: Inset

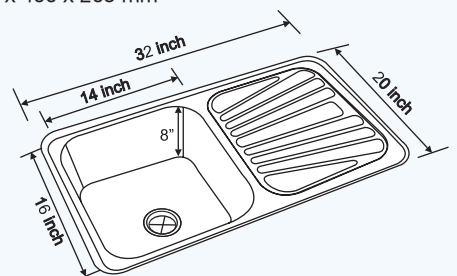

Single Bowl Single Drain Board

• Inset • Undermount • Lay-on / Beeded

The elegant, uniform balance of sink and drain board to give space for working & washing.



Single Bowl Single Drain Board

• Inset • Undermount • Lay-on / Beeded



PEARL

CODE : NK SBSD22 G/M

Specification

OVERALL SIZE: 32 x 20 inch 815 x 510 mm	FINISH: Matt & Gloss
BOWL SIZE: 14 x 16 x 8 inch 350 x 400 x 205 mm	PROFILE: Lay-on & Beeded

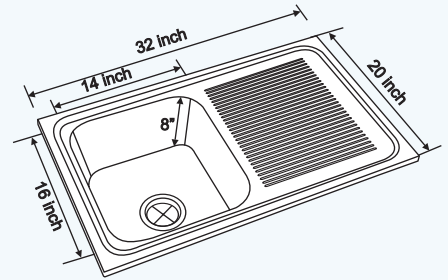

CODE : NK SBSD21 G/M

Specification

OVERALL SIZE: 36 x 20 inch 915 x 510 mm	FINISH: Matt & Gloss
BOWL SIZE: 20 x 16 x 8 inch 510 x 410 x 205 mm	PROFILE: Lay-on & Beeded

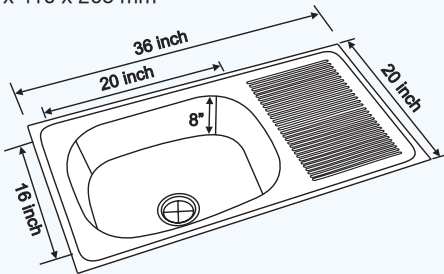

DECOR



EVO 3718 SBSD

CODE : NK SBSD19 G/M

Specification

OVERALL SIZE: 37 x 18¼ inch 940 x 465 mm	FINISH: Matt & Gloss
BOWL SIZE: 17 x 15 x 9 inch 430 x 380 x 230 mm	PROFILE: Lay-on & Beeded

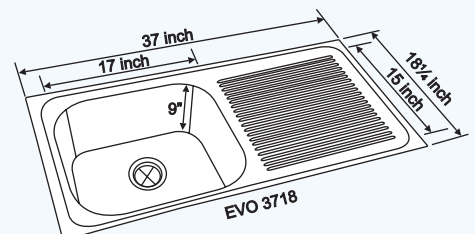

Single Bowl Single Drain Board

- Inset • Undermount • Lay-on / Beeded



JPM IIND

CODE : NK SBSD20 G/M

Specification

OVERALL SIZE: 37 x 18 inch 940 x 465 mm	FINISH: Matt & Gloss
BOWL SIZE: 16 x 14 x 8 inch 400 x 350 x 205 mm	PROFILE: Lay-on & Beeded

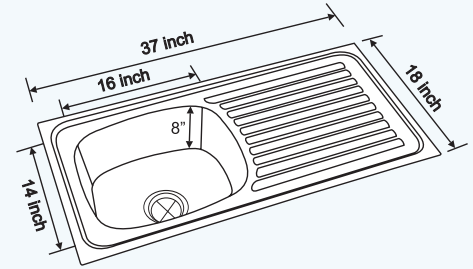

CODE : NK SBSD5 M

Specification

OVERALL SIZE: 36 x 18 inch 915 x 460 mm	FINISH: Matt
BOWL SIZE: 16 x 14 x 8 inch 400 x 350 x 205 mm	PROFILE: Inset

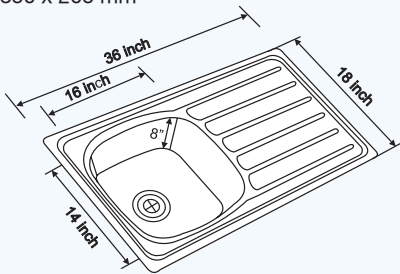

INSET 3618 SBSD (R)



LAY-ON LN 3719 SBSD

CODE : NK SBSD10 L

Specification

OVERALL SIZE: 37 x 19 inch 940 x 485 mm	FINISH: Linen
BOWL SIZE: 14 x 16 x 7 inch 350 x 400 x 180 mm	PROFILE: Lay-on

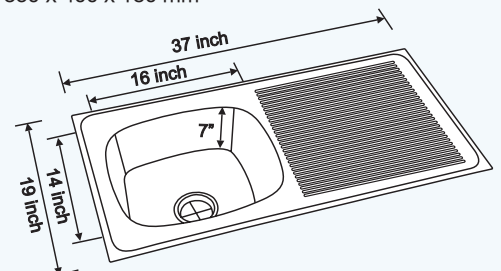

Single Bowl Single Drain Board

- Inset • Undermount • Lay-on / Beeded



INSET 3820 SBSD (R)

CODE : NK SBSD4 M

Specification

OVERALL SIZE:	FINISH:
38 x 20 inch	Matt
965 x 510 mm	
BOWL SIZE:	PROFILE:
17 x 15 x 9 inch	Inset
430 x 385 x 230 mm	

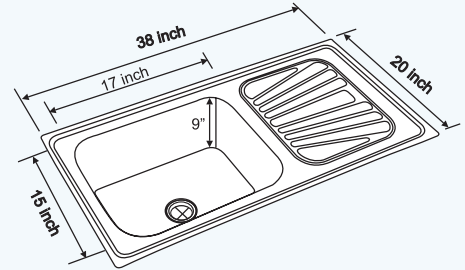

CODE : NK SBSD3 M

Specification

OVERALL SIZE:	FINISH:
40 x 20 inch	Matt
1015 x 510 mm	
BOWL SIZE:	PROFILE:
20 x 16 x 8 inch	Inset
510 x 410 x 205 mm	



INSET 4020 SBSD (R)



ELLYSSE (NEW)

CODE : NK SBSD18 G/M

Specification

OVERALL SIZE:	FINISH:
40 x 20 inch	Matt & Gloss
1015 x 510 mm	
BOWL SIZE:	PROFILE:
20 x 16 x 8 inch	Lay-on & Beeded
510 x 410 x 205 mm	

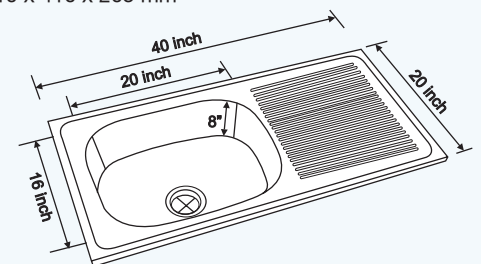

Single Bowl Single Drain Board

- Inset • Undermount • Lay-on / Beeded



CODE : NK SBS D7 L

Specification

OVERALL SIZE:	FINISH:
40 x 20 inch	Linen
1015 x 510 mm	
BOWL SIZE:	PROFILE:
20 x 16 x 8 inch	Inset
510 x 410 x 205 mm	

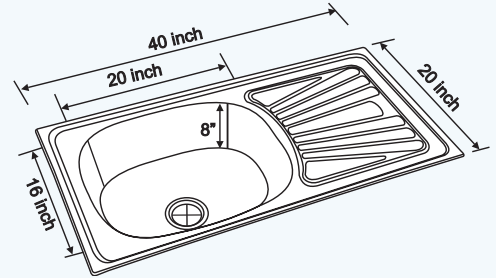

CODE : NK SBS D17 G/M

Specification

OVERALL SIZE:	FINISH:
41 x 20 inch	Matt & Gloss
1040 x 510 mm	
BOWL SIZE:	PROFILE:
18 x 16 x 8 inch	Lay-on & Beeded
460 x 410 x 205 mm	

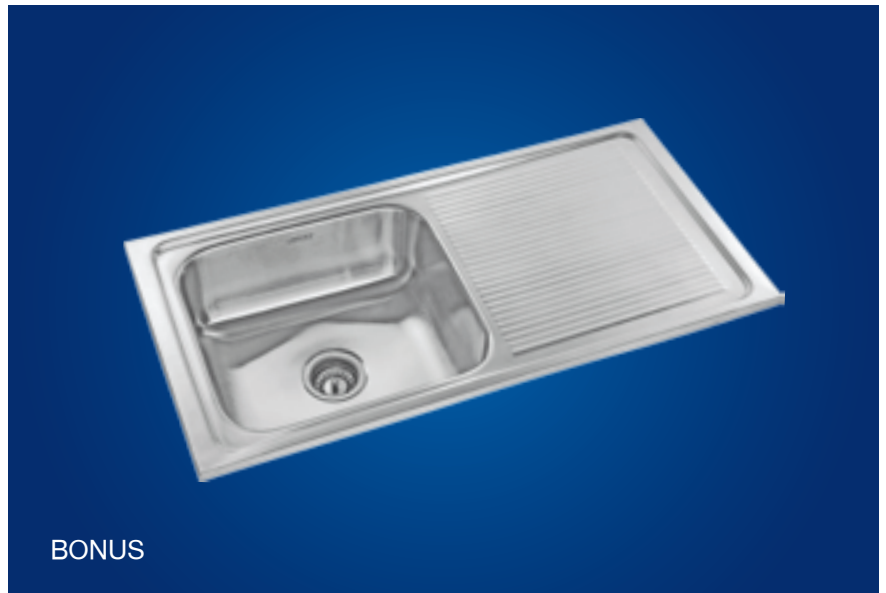
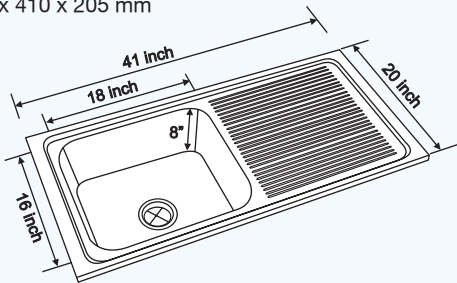

CODE : NK SBS D9 L

Specification

OVERALL SIZE:	FINISH:
45 x 20 inch	Linen
1145 x 510 mm	
BOWL SIZE:	PROFILE:
20 x 16 x 8 inch	Lay-on
510 x 410 x 205 mm	

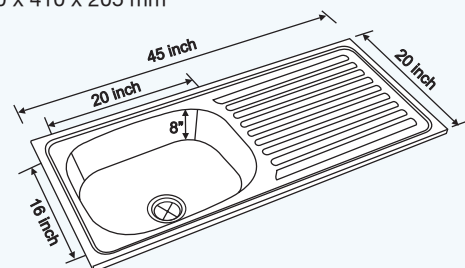

Single Bowl Single Drain Board

• Inset • Undermount • Lay-on / Beeded



PACE MAKER 10" & PACE MAKER 8"

CODE : NK SBSD15 G/M &
NK SBSD16 G/M

Specification

OVERALL SIZE: 45½ x 20½ inch 1155 x 525 mm	FINISH: Matt & Gloss
BOWL SIZE: 20 x 16 x 10/8 inch 510 x 410 x 255/205 mm	PROFILE: Lay-on & Beeded

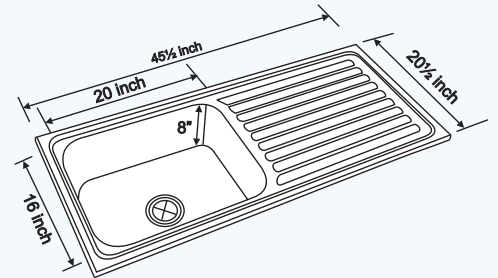

CODE : NK SBSD13 G/M &
NK SBSD14 G/M

Specification

OVERALL SIZE: 56 x 22 inch 1420 x 555 mm	FINISH: Matt & Gloss
BOWL SIZE: 24 x 18 x 10/8 inch 610 x 460 x 255/205 mm	PROFILE: Lay-on

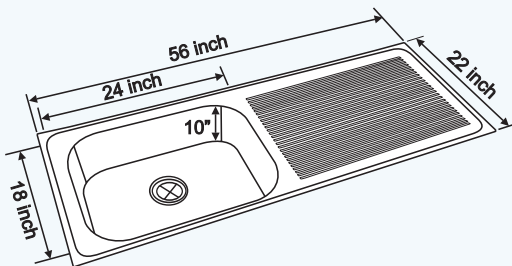

IMPEL KING 10" & IMPEL KING 8"



Double Bowl

- Inset • Undermount • Lay-on / Beeded

New age design of Neelkanth double bowl sink for all time eaters but choosy & selective.



• Inset • Undermount • Lay-on / Beeded



STATE LINE 4818 DB

CODE : NK DB22 M

Specification

OVERALL SIZE: 48 x 18 inch 1220 x 460 mm	FINISH: Matt	THICKNESS: 1.2 mm
BOWL SIZE: 22 x 16 x 9 inch (DB) 555 x 405 x 230 mm	PROFILE: Undermount	

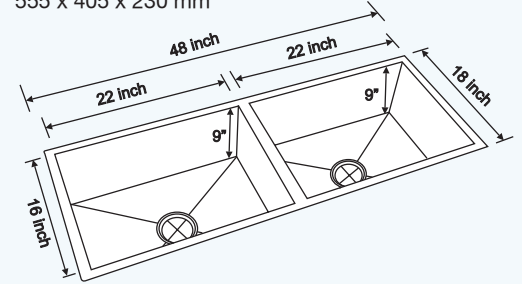

CODE : NK DB21 M

Specification

OVERALL SIZE: 34¼ x 19¼ inch 870 x 490 mm	FINISH: Matt	THICKNESS: 1.2 mm
BOWL SIZE: 17½ x 15¾ x 8 inch (DB) 445 x 400 x 205 mm	PROFILE: Undermount	

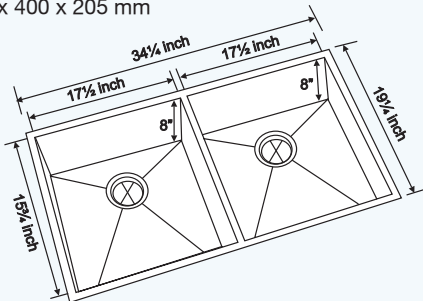

STATE LINE DB 3419



UNDERMOUNT NUH 2818

CODE : NK DB5 M

Specification

OVERALL SIZE: 28 x 18 inch 711 x 456 mm	FINISH: Matt
BOWL SIZE: 14 x 16 x 8 inch 350 x 400 x 205 mm 10½ x 12½ x 6½ inch 270 x 315 x 165 mm	PROFILE: Undermount

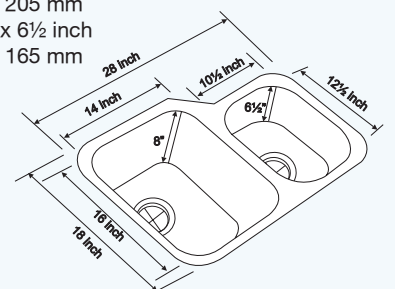

Double Bowl

- Inset • Undermount • Lay-on / Beeded

D-line series double bowl sink made in combination of D-line and rectangular shape bowl give a unique unconventional look to your kitchen and give thought of jealous to your visiting ...



• Inset • Undermount • Lay-on / Beeded



UNDERMOUNT 3220 D RHS/LHS

CODE : NK DB9 M

Specification

OVERALL SIZE:
32 x 20 inch
810 x 510 mm

FINISH:
Matt

BOWL SIZE:
17¼ x 17¼ x 9 inch
450 x 440 x 230 mm
16 x 10¼ x 6½ inch
400 x 260 x 165 mm

PROFILE:
Undermount

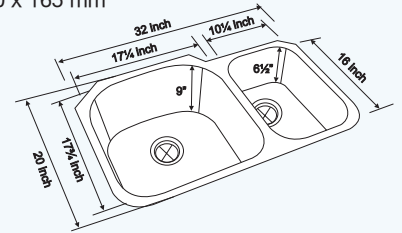

CODE : NK DB7 M

Specification

OVERALL SIZE:
31¼ x 18 inch
796 x 456 mm

FINISH:
Matt

BOWL SIZE:
14 x 16 x 8 inch
350 x 400 x 205 mm
14 x 16 x 8 inch
350 x 400 x 205 mm

PROFILE:
Undermount

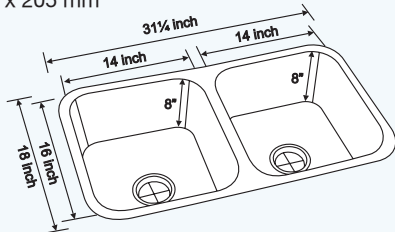

UNDERMOUNT NUH 3118



UNDERMOUNT NUH 3220

CODE : NK DB6 M

Specification

OVERALL SIZE:
32 x 20 inch
813 x 510 mm

FINISH:
Matt

BOWL SIZE:
15 x 18 x 10 inch
380 x 460 x 255 mm
14 x 16 x 8 inch
350 x 400 x 205 mm

PROFILE:
Undermount

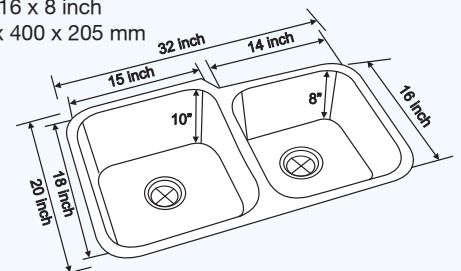

• Inset • Undermount • Lay-on / Beeded



UNDERMOUNT OFFSET LN 3220

CODE : NK DB8 L

Specification

OVERALL SIZE:	FINISH:
32 x 20 inch	Linen
810 x 510 mm	
BOWL SIZE:	PROFILE:
15 x 18 x 9 inch	Undermount
375 x 450 x 230 mm	
14 x 16 x 8 inch	
350 x 400 x 205 mm	

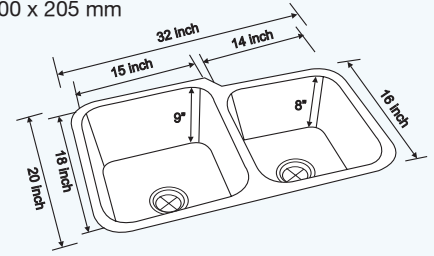

CODE : NK DB24 Two Tone

Specification

OVERALL SIZE:	FINISH:
31 x 20 inch	Two Tone
788 x 510 mm	
BOWL SIZE:	PROFILE:
14 x 16 x 8 inch (DB)	Topmount
350 x 400 x 205 mm	

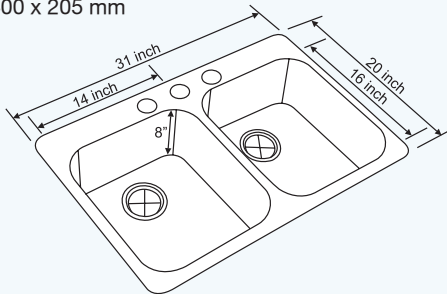

TOPMOUNT 3120



INSET 3220 OHB (R)

CODE : NK DB2 M

Specification

OVERALL SIZE:	FINISH:
32 x 20 inch	Matt
810 x 510 mm	
BOWL SIZE:	PROFILE:
14 x 16 x 8 inch	Inset
350 x 400 x 205 mm	
12½ x 10½ x 6 inch	
320 x 270 x 152 mm	

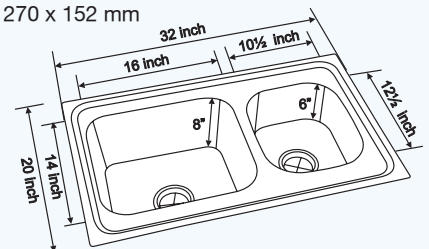

• Inset • Undermount • Lay-on / Beeded



JR. VICTOR TWIN

CODE : NK DB20 G/M

Specification

OVERALL SIZE:
37 x 19¼ inch
940 x 490 mm

FINISH:
Matt & Gloss

BOWL SIZE:
16 x 14 x 8 inch (DB)
400 x 350 x 205 mm

PROFILE:
Lay-on & Beeded

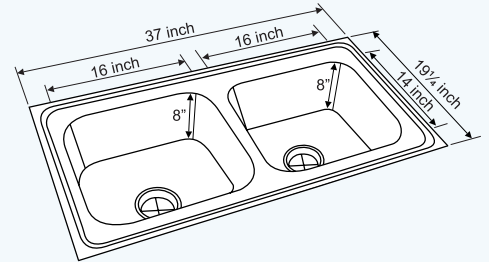

CODE : NK DB19 G/M

Specification

OVERALL SIZE:
40 x 20 inch
1015 x 510 mm

FINISH:
Matt & Gloss

BOWL SIZE:
20 x 16 x 8 inch
510 x 410 x 205 mm
14 x 16 x 8 inch
350 x 400 x 205 mm

PROFILE:
Lay-on & Beeded

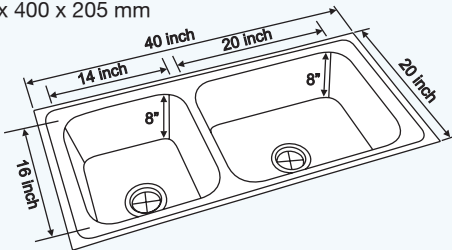

COMBO TWIN



INSET 4520 DB (R)

CODE : NK DB1 M

Specification

OVERALL SIZE:
45½ x 20½ inch
1155 x 515 mm

FINISH:
Matt

BOWL SIZE:
20 x 16 x 10 inch (DB)
510 x 410 x 255 mm

PROFILE:
Inset

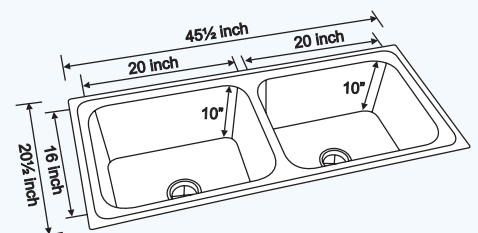

Double Bowl

- Inset • Undermount • Lay-on / Beeded

Double bowl sinks carry an extra advantage of utility, soap in one & wash in other bowl.



• Inset • Undermount • Lay-on / Beeded



MEDIUM VICTOR TWIN 10"

CODE : NK DB18 G/M

Specification

OVERALL SIZE: 42 x 20 inch 1066.8 x 510 mm	FINISH: Matt & Gloss
BOWL SIZE: 18 x 15 x 10 inch (DB) 460 x 380 x 255 mm	PROFILE: Lay-on & Beeded

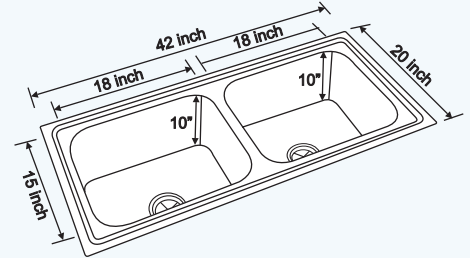

CODE : NK DB11 L

Specification

OVERALL SIZE: 48 x 20 inch 1220 x 510 mm	FINISH: Linen
BOWL SIZE: 20 x 16 x 8 inch (DB) 510 x 410 x 205 mm	PROFILE: Lay-on

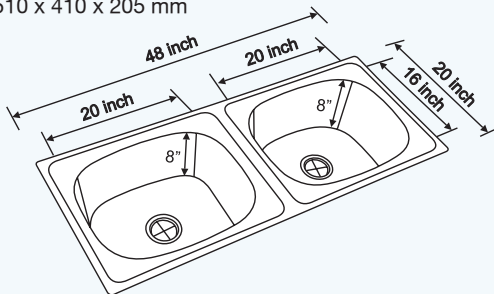

LAY-ON LN 4820 DB



INSET LN 4820 DB (R)

CODE : NK DB4 L

Specification

OVERALL SIZE: 48 x 20 inch 1220 x 510 mm	FINISH: Linen
BOWL SIZE: 20 x 16 x 8 inch (DB) 510 x 410 x 205 mm	PROFILE: In-set

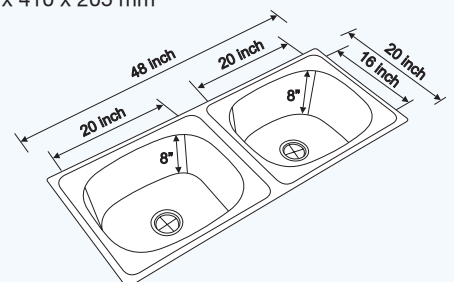

Double Bowl

- Inset • Undermount • Lay-on / Beeded



• Inset • Undermount • Lay-on / Beeded



VICTOR TWIN 10" & VICTOR TWIN 8"

CODE : NK DB16 G/M & NK DB17 G/M

Specification

OVERALL SIZE:
45½ x 20½ inch
1155 x 515 mm

FINISH:
Matt & Gloss

BOWL SIZE:
20 x 16 x 10/8 inch (DB)
510 x 410 x 255/205 mm

PROFILE:
Lay-on & Beeded

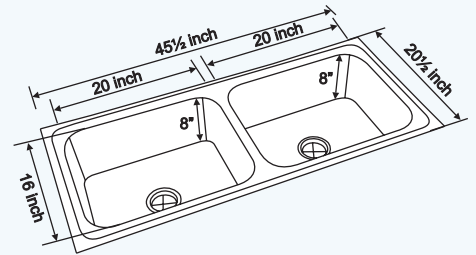

CODE : NK DB23 G/M

Specification

OVERALL SIZE:
48 x 20 inch
1220 x 510 mm

FINISH:
Matt & Gloss

BOWL SIZE:
28 x 16 x 10 inch
712 x 410 x 255 mm
14 x 16 x 8 inch
350 x 410 x 205 mm

PROFILE:
Lay-on & Beeded

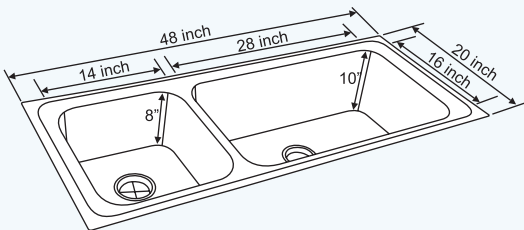

4820 DB (R)



IMPEL TWIN 10" & IMPEL TWIN 8"

CODE : NK DB13 G/M & NK DB14 G/M

Specification

OVERALL SIZE:
54 x 24 inch
1370 x 610 mm

FINISH:
Matt & Gloss

BOWL SIZE:
24 x 18 x 10/8 inch (DB)
610 x 460 x 255/205 mm

PROFILE:
Lay-on

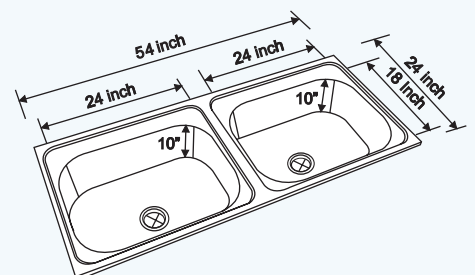

Double Bowl Single Drainer

- Inset • Undermount • Lay-on / Beeded

The best ever creative handcraft sink to enhanced the grace of your kitchen with our 0 radius sink with three drain separators to enjoy washing of utensils as well as cleaning veggies , fruits and cutlery.



Double Bowl Single Drainer

- Inset • Undermount • Lay-on / Beeded



STATE LINE DBSD 4819 RHS/LHS

CODE : NK DBSD21 M

Specification

OVERALL SIZE: 48 x 19¼ inch 1220 x 490 mm	FINISH: Matt	THICKNESS: 1.2 mm
BOWL SIZE: 17½ x 16 x 8 inch (DB) 445 x 410 x 205 mm	PROFILE: Undermount	

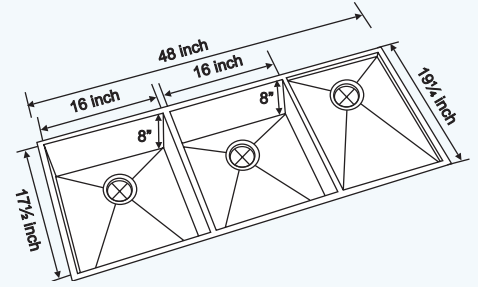

CODE : NK DBSD12 G/M & NK DBSD13 G/M

Specification

OVERALL SIZE: 68½ x 20½ inch 1740 x 515 mm	FINISH: Matt & Gloss
BOWL SIZE: 20 x 16 x 10/8 inch (DB) 510 x 410 x 255/205 mm	PROFILE: Lay-on

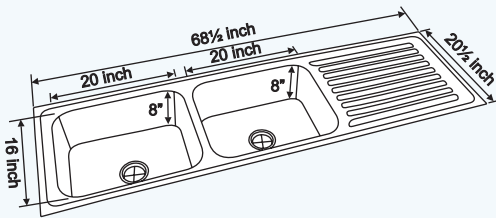

LUSTER TWIN 10" & LUSTER TWIN 8"



M. LUSTER TWIN 10" & M. LUSTER TWIN 8"

CODE : NK DBSD14 G/M & NK DBSD15 G/M

Specification

OVERALL SIZE: 60 x 20 inch 1525 x 510 mm	FINISH: Matt & Gloss
BOWL SIZE: 20 x 16 x 10/8 inch (DB) 510 x 410 x 255/205 mm	PROFILE: Lay-On

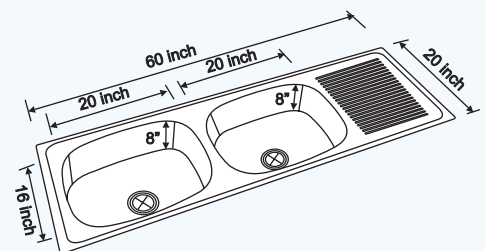

Double Bowl Single Drainer

- Inset • Undermount • Lay-on / Beeded



INSET 6020 OHBSD (R)

CODE : NK DBSD2 M

Specification

OVERALL SIZE: 60 x 20 inch 1525 x 510 mm	FINISH: Matt
BOWL SIZE: 20 x 16 x 8 inch 510 x 410 x 205 mm 14 x 16 x 8 inch 350 x 400 x 205 mm	PROFILE: Inset

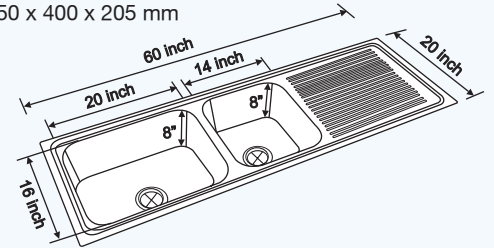

CODE : NK DBSD19 G/M

Specification

OVERALL SIZE: 54 x 18 inch 1370 x 460 mm	FINISH: Matt & Gloss
BOWL SIZE: 17 x 15 x 9 inch (DB) 430 x 380 x 230 mm	PROFILE: Lay-on

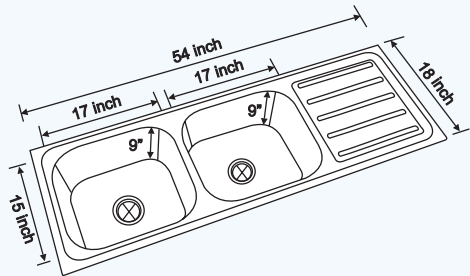

ALEXENDER 5418 DBSD



JUNIOR LUSTER TWIN 8"

CODE : NK DBSD16 G/M

Specification

OVERALL SIZE: 54 x 18 inch 1370 x 460 mm	FINISH: Matt & Gloss
BOWL SIZE: 16 x 14 x 8 inch (DB) 400 x 350 x 205 mm	PROFILE: Lay-on

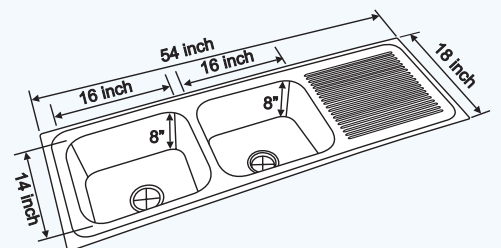

Double Bowl Single Drainer

• Inset • Undermount • Lay-on / Beeded



INSET LN 5020 DBSD (R)

CODE : NK DBSD5 L

Specification

OVERALL SIZE: 50 x 20 inch 1270 x 510 mm	FINISH: Linen
BOWL SIZE: 14 x 16 x 8 inch 350 x 400 x 205 mm 14 x 16 x 7 inch 350 x 400 x 180 mm	PROFILE: Inset

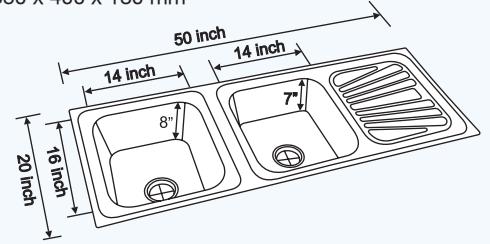

CODE : NK DBSD1 M

Specification

OVERALL SIZE: 48 x 20 inch 1220 x 510 mm	FINISH: Matt
14 x 16 x 8 inch (DB) 350 x 400 x 205 mm	PROFILE: Inset

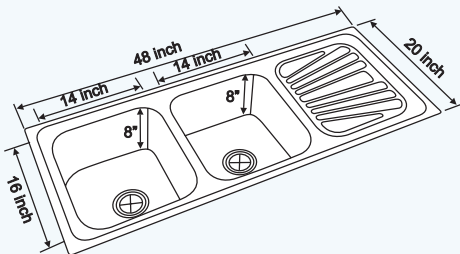

INSET 4820 DBSD (R)



INSET 4520 OHBSD (R)

CODE : NK DBSD3 M

Specification

OVERALL SIZE: 45 x 20 inch 1145 x 510 mm	FINISH: Matt
BOWL SIZE: 14 x 16 x 8 inch 350 x 400 x 205 mm 10½ x 12½ x 6 inch 270 x 320 x 150 mm	PROFILE: Inset

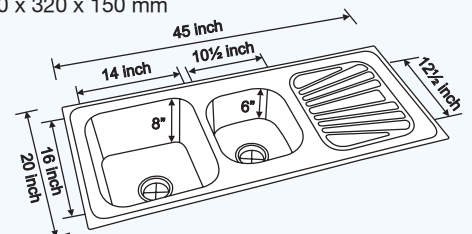

Double Bowl Single Drainer

• Inset • Undermount • Lay-on / Beeded



CODE : NK DBSD20 G/M

Specification

OVERALL SIZE:	FINISH:
48 x 20 inch 1220 x 510 mm	Matt & Gloss
BOWL SIZE:	PROFILE:
14 x 16 x 8 inch (DB) 350 x 400 x 205 mm	Beeded

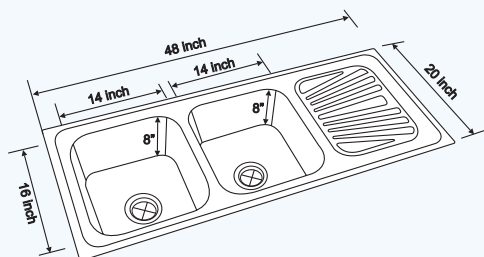

Double Bowl Single Drainer

• Inset • Undermount • Lay-on / Beeded



CODE : NK DBSD20 G/M
MODEL : AVIATOR

Double Bowl Single Drainer

- Inset • Undermount • Lay-on / Beeded

The person who have space and choice can select these sinks to match their life style.



Double Bowl Single Drainer

• Inset • Undermount • Lay-on / Beeded



CORNETO 4520 OHBSD

CODE : NK DBSD18 G/M

Specification

OVERALL SIZE: 45½ x 20½ inch 1155 x 520 mm	FINISH: Matt & Gloss
BOWL SIZE: 20 x 16 x 8 inch 510 x 410 x 205 mm 16 x 10½ x 7 inch 410 x 265 x 185 mm	PROFILE: Lay-on & Beeded

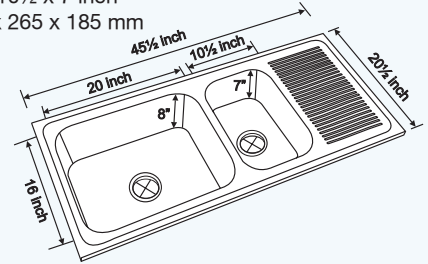

CODE : NK DBSD17 G/M

Specification

OVERALL SIZE: 40 x 20 inch 1015 x 510 mm	FINISH: Matt & Gloss
BOWL SIZE: 16 x 14 x 8 inch 400 x 350 x 205 mm 16 x 10½ x 7 inch 410 x 265 x 185 mm	PROFILE: Lay-on & Beeded

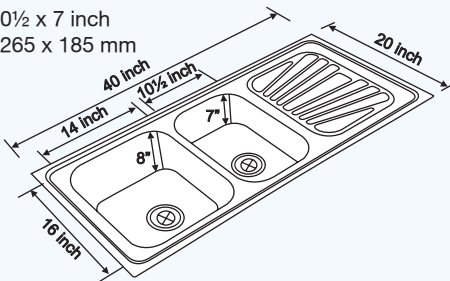

AMILO 4020 OHBSD



INSET 4020 OHBSD (R)

CODE : NK DBSD4 M

Specification

OVERALL SIZE: 40 x 20 inch 1015 x 510 mm	FINISH: Matt
BOWL SIZE: 14 x 16 x 8 inch 350 x 400 x 205 mm 5½ x 13 x 4½ inch 140 x 325 x 115 mm	PROFILE: Inset

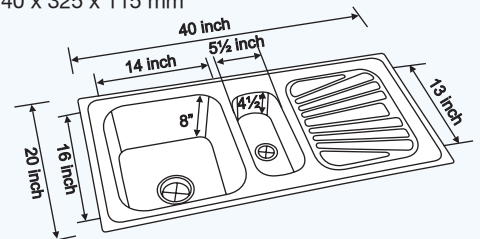

Double Bowl Double Drainer

- Inset • Undermount • Lay-on / Beeded

Having a farm house and found of parties select the below sink.



Double Bowl Double Drainer

- Inset • Undermount • Lay-on / Beeded



JUMBO 9020 DBDD 8"

CODE : NK DBDD1 G/M

Specification

OVERALL SIZE: 90 x 20 inch 2285 x 510 mm	FINISH: Matt & Gloss
BOWL SIZE: 20 x 16 x 8 inch (DB) 510 x 410 x 205 mm	PROFILE: Lay-on

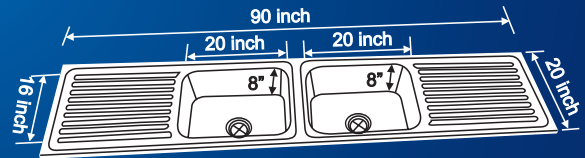

PRIMO TWIN 7418 DBDD

CODE : NK DBDD2 G/M

Specification

OVERALL SIZE: 74 x 18 inch 1880 x 460 mm	FINISH: Matt & Gloss
BOWL SIZE: 14 x 16 x 8 inch (DB) 350 x 400 x 205 mm	PROFILE: Lay-on

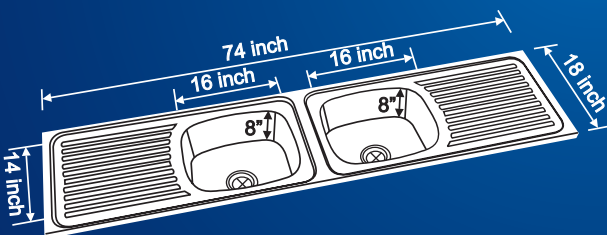

Triple Bowl

- Inset • Undermount • Lay-on / Beeded

Our triple bowl give separate space for utensils, cutlery and crockery.



• Inset • Undermount • Lay-on / Beeded



IMPEL 111 8224 10" & IMPEL 8224 111 8"

CODE : NK TB3 G/M & NK TB4 G/M

Specification

OVERALL SIZE:	FINISH:
82½ x 24 inch	Matt & Gloss
2096 x 610 mm	
BOWL SIZE:	PROFILE:
24 x 18 x 10/8 inch (TB)	Lay-on
610 x 460 x 255/205 mm	

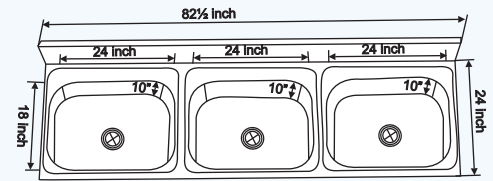

CODE : NK TB1 M

Specification

OVERALL SIZE:	FINISH:
48 x 20 inch	Matt
1220 x 510 mm	
BOWL SIZE:	PROFILE:
18 x 15 x 8 inch (DB)	Inset
450 x 375 x 205 mm	
5½ x 13 x 4½ inch	
140 x 325 x 115 mm	

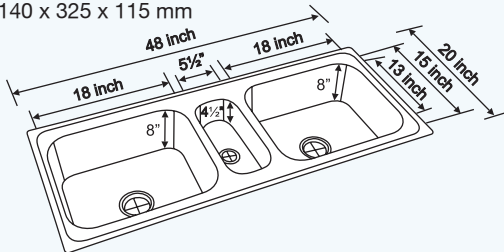

INSET 4820 THB (R)



INSET 4520 THB (R)

CODE : NK TB2 M

Specification

OVERALL SIZE:	FINISH:
45¼ x 20½ inch	Matt
1155 x 520 mm	
BOWL SIZE:	PROFILE:
14 x 16 x 8 inch (DB)	Inset
350 x 400 x 205 mm	
10½ x 12½ x 6 inch	
240 x 315 x 150 mm	

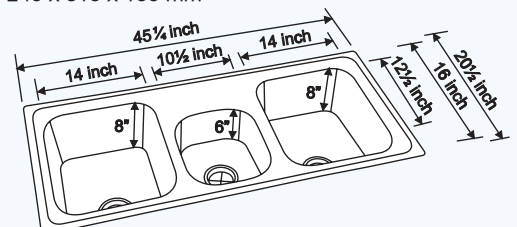

Triple Bowl Single Drainer

- Inset • Undermount • Lay-on / Beeded

Dream kitchen sink give you the complete freedom in your kitchen with the facility of washing utensils, cutlery, crockery and drip tray for the washing of veggies and fruits.



Triple Bowl Single Drainer

• Inset • Undermount • Lay-on / Beeded

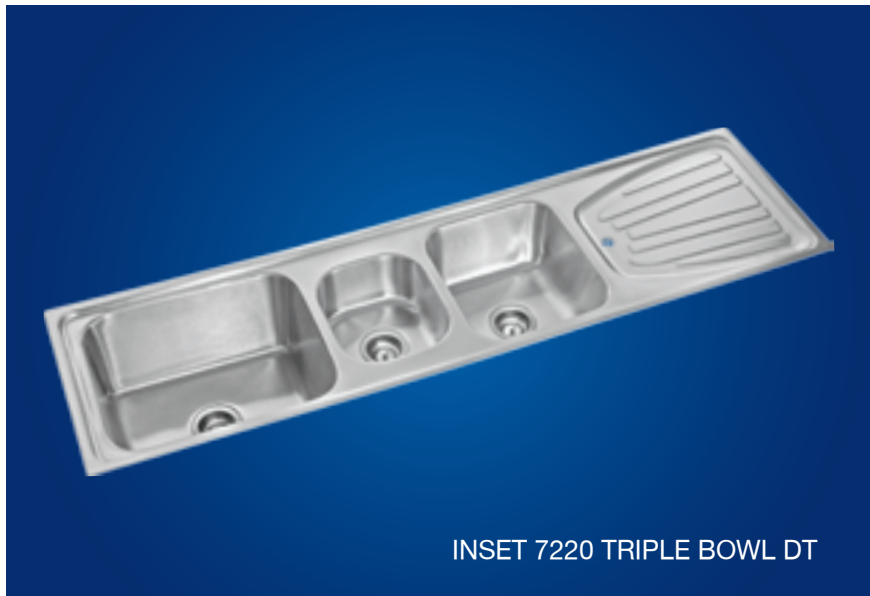

INSET 7220 TRIPLE BOWL DT

CODE : NK TBSD2 M

Specification

OVERALL SIZE: 72 x 20 inch 1830 x 510 mm	FINISH: Matt
BOWL SIZE: 20 x 16 x 10 inch 510 x 410 x 255 mm 10½ x 12½ x 6 inch 270 x 320 x 155 mm 14 x 16 x 8 inch 355 x 410 x 205 mm	PROFILE: Inset

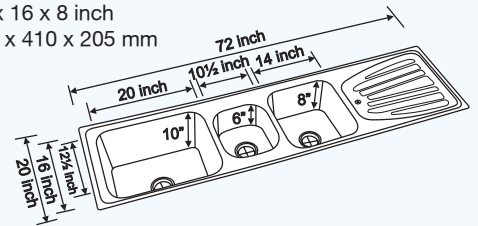

CODE : NK TBSD4 G/M

Specification

OVERALL SIZE: 72 x 20 inch 1830 x 510 mm	FINISH: Matt & Gloss
BOWL SIZE: 20 x 16 x 8 inch (DB) 510 x 410 x 205 mm 5½ x 13 x 4½ inch 140 x 330 x 115 mm	PROFILE: Lay-on

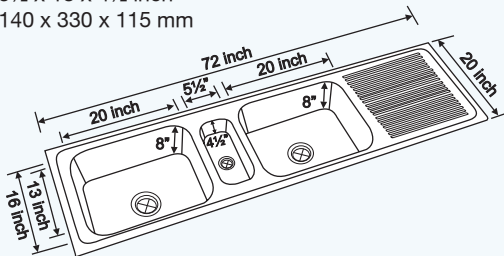

YARD LINER DX (QB+CB+GB)



INSET 6820 TQB DT (R)

CODE : NK TBSD1 M

Specification

OVERALL SIZE: 68 x 20 inch 1730 x 510 mm	FINISH: Matt
BOWL SIZE: 18 x 15 x 10 inch (DB) 460 x 385 x 255 mm 5½ x 13 x 4½ inch 140 x 330 x 115 mm	PROFILE: Inset

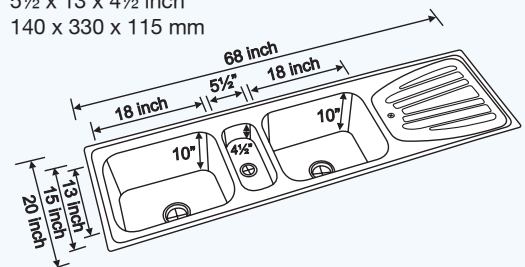

Compact Series

Compact Series offer range of sinks with additional accessories such as chopping board and free moving sliding garbage bin to work in style. This series offer five different models in one over all size 48 x 20 inches.



Double Bowl Drain Board with Waste Bins & chopping board

• Inset • Undermount • Lay-on / Beeded



CODE : NK DBSD7 G/M
MODEL : COMPAQT II



COMPAQt I (CB+GB)

CODE : NK DBSD6 G/M

Specification

OVERALL SIZE: 48 x 20 inch 1220 x 510 mm	FINISH: Matt & Gloss
BOWL SIZE: 20 x 16 x 8 inch 510 x 410 x 205 mm 14 x 16 x 8 inch 350 x 400 x 205 mm	PROFILE: Lay-On

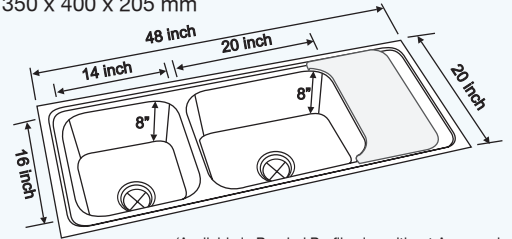

(Available in Beeded Profile also without Accessories)

CODE : NK DBSD7 G/M

Specification

OVERALL SIZE: 48 x 20 inch 1220 x 510 mm	FINISH: Matt & Gloss
BOWL SIZE: 14 x 16 x 8 inch (DB) 350 x 400 x 205 mm	PROFILE: Lay-On

(Available in Beeded Profile also without Accessories)



COMPAQt II (CB+GB)



COMPAQt III (MB+CB)

CODE : NK TB5 G/M

Specification

OVERALL SIZE: 48 x 20 inch 1220 x 510 mm	FINISH: Matt & Gloss
BOWL SIZE: 18 x 15 x 8 inch (DB) 460 x 385 x 205 mm 5½ x 13 x 4½ inch 140 x 330 x 115 mm	PROFILE: Lay-On

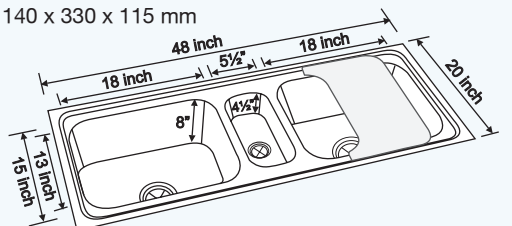

(Available in Beeded Profile also without Accessories)

- Lay-on Sinks



COMPAQt IV (MB+CB+GB)

CODE : NK TBSD3 G/M

Specification

OVERALL SIZE: 48 x 20 inch 1220 x 510 mm	FINISH: Matt & Gloss
BOWL SIZE: 14 x 16 x 8 inch (DB) 350 x 400 x 205 mm 5½ x 13 x 4½ inch 140 x 330 x 115 mm	PROFILE: Lay-On

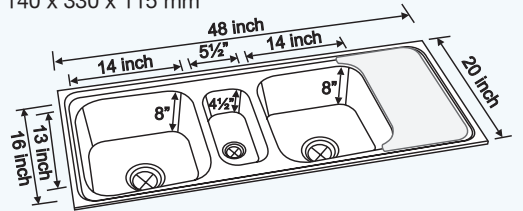

(Available in Beeded Profile also without Accessories)

CODE : NK DBSD8 G/M

Specification

OVERALL SIZE: 48 x 20 inch 1220 x 510 mm	FINISH: Matt & Gloss
BOWL SIZE: 20 x 16 x 8 inch 510 x 410 x 205 mm 5½ x 13 x 4½ inch 140 x 330 x 115 mm	PROFILE: Lay-On

(Available in Beeded Profile also without Accessories)



COMPAQt V (CB+GB)



Junior Compact Series

Junior Compact Series offer range of sinks with additional accessories such as chopping board and free moving sliding garbage bin to work in style. This series offer six different models in one over all size 32 x 20 inches.



Double Bowl Drain Board with Waste Bins & chopping board

• Inset • Undermount • Lay-on / Beeded



CODE : NK DBSD9 G/M
MODEL : JR. COMPAQT III



JR. COMPAQt I (CB+GB)

CODE : NK SBSD11 G/M

Specification

OVERALL SIZE: 32 x 20 inch 810 x 510 mm	FINISH: Matt & Gloss
BOWL SIZE: 14 x 16 x 8 inch 350 x 400 x 205 mm	PROFILE: Lay-On

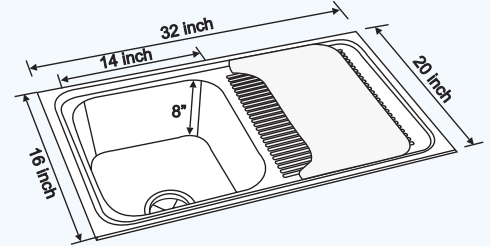

(Available in Beeded Profile also without Accessories)

CODE : NK DB12 G/M

Specification

OVERALL SIZE: 32 x 20 inch 810 x 510 mm	FINISH: Matt & Gloss
BOWL SIZE: 20 x 16 x 8 inch 510 x 410 x 205 mm 5½ x 13 x 4½ inch 140 x 330 x 115 mm	PROFILE: Lay-On

(Available in Beeded Profile also without Accessories)



JR. COMPAQt II (CB)



JR. COMPAQt III (MB+CB+GB)

CODE : NK DBSD9 G/M

Specification

OVERALL SIZE: 32 x 20 inch 810 x 510 mm	FINISH: Matt & Gloss
BOWL SIZE: 14 x 16 x 8 inch 350 x 400 x 205 mm 5½ x 13 x 4½ inch 140 x 330 x 115 mm	PROFILE: Lay-On

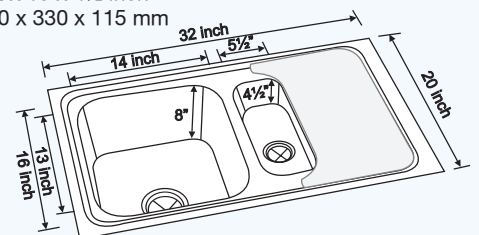

(Available in Beeded Profile also without Accessories)



JR. COMPAQt IV (CB+GB)

CODE : NK SBSD12 G/M

Specification

OVERALL SIZE: 32 x 20 inch 810 x 510 mm	FINISH: Matt & Gloss
BOWL SIZE: 20 x 16 x 8 inch 510 x 410 x 205 mm	PROFILE: Lay-On

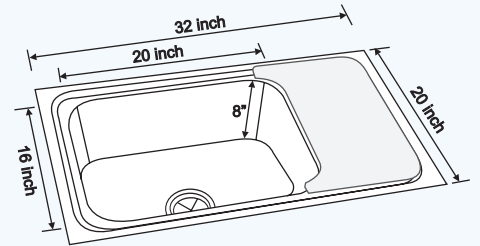

(Available in Beeded Profile also without Accessories)

CODE : NK DBSD11 G/M

Specification

OVERALL SIZE: 40 x 20 inch 1015 x 510 mm	FINISH: Matt & Gloss
BOWL SIZE: 14 x 16 x 8 inch 350 x 400 x 205 mm 5½ x 13 x 4½ inch 140 x 330 x 115 mm	PROFILE: Lay-on



ELLYSSE DX (QB+CB+GB)



ELLYSSE DX

CODE : NK DBSD10 G/M

Specification

OVERALL SIZE: 40 x 20 inch 1015 x 510 mm	FINISH: Matt & Gloss
BOWL SIZE: 14 x 16 x 8 inch 350 x 400 x 205 mm 5½ x 13 x 4½ inch 140 x 330 x 115 mm	PROFILE: Beeded

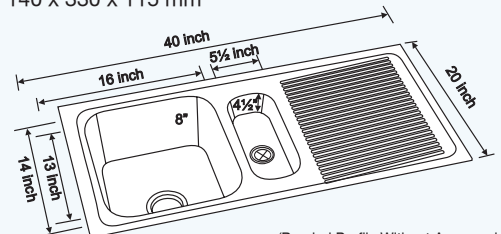

(Beeded Profile Without Accessories)



Wash Basins

- Undermount

Bathroom wash basin of semi glare create a different look to your bathroom and gel with all type of counter top.





WB 01

CODE : NK WB 01 G/M

Specification

OVERALL SIZE: 23 X 14¼ inch 585 X 360 mm Dia 585 mm	FINISH: Matt & Gloss
BOWL SIZE: 13¾ X 10¼ X ¾ inch 350 x 260 x 85 mm	PROFILE: Lay-on

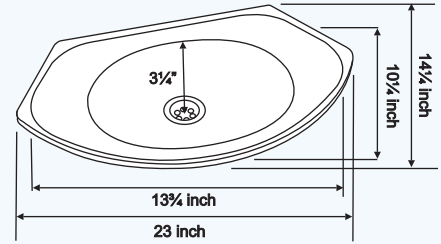

CODE : NK WB02 G/M

Specification

OVERALL SIZE: 16½ X 10¾ inch 425 X 275 mm Dia 425 mm	FINISH: Matt & Gloss
BOWL SIZE: 15¼ X 10 X 2¼ inch 400 X 252 X 60 mm	PROFILE: Undermount



WB 02



WB 03

CODE : NK WB03 G/M

Specification

OVERALL SIZE: 17" X 12½" 435 X 317 mm Dia 434 mm	FINISH: Matt & Gloss
BOWL SIZE: 15¼ X 10¾ X ¾ inch 385 X 272 X 92 mm	PROFILE: Undermount

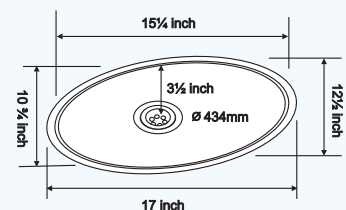



CODE : NK AC01, NK AC02

Specification

OVERALL SIZE:	FINISH:
5 inch	Gloss
125 mm	
6 inch	PROFILE:
150 mm	Square Flang

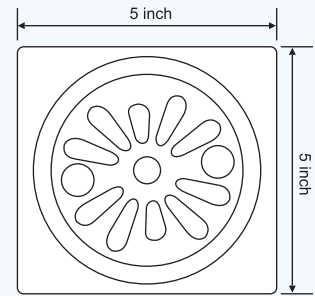

CODE : NK AC03

Specification

OVERALL SIZE:	FINISH:
Dia 5 inch	Gloss
125 mm	
	PROFILE:
	Round Flange

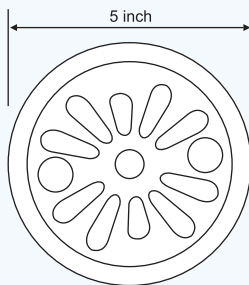

CODE : NK AC04

Specification

OVERALL SIZE:	FINISH:
Dia 3.5 inch	Gloss
90 mm	

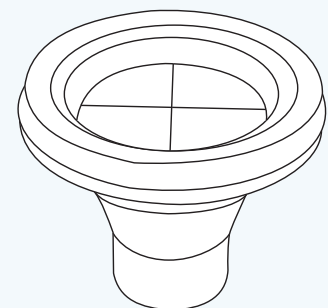



GARBAGE BIN SYSTEM

CODE : NK AC 05

Specification

OVERALL SIZE:

9 X 7½ inch DEPTH: 20 inch
230 X 190 mm 510 mm

GARBAGE BIN SIZE:

11 X 8 X 11½ inch
280 x 205 x 292 mm

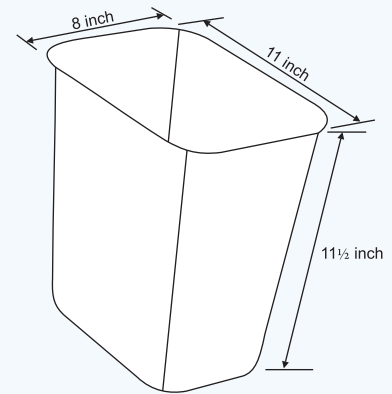

CODE : NK AC06

Specification

OVERALL SIZE:

18 X 11¾ inch
460 X 300 mm

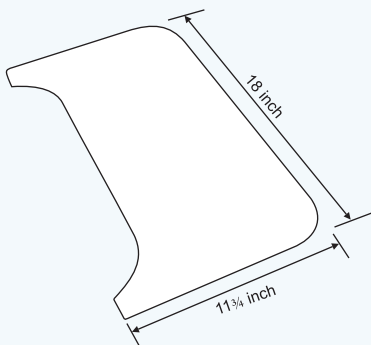

CHOPPING BOARD

Waste Coupling Assembly

Stainless Steel Accessories



Installation Instruction For Coupling

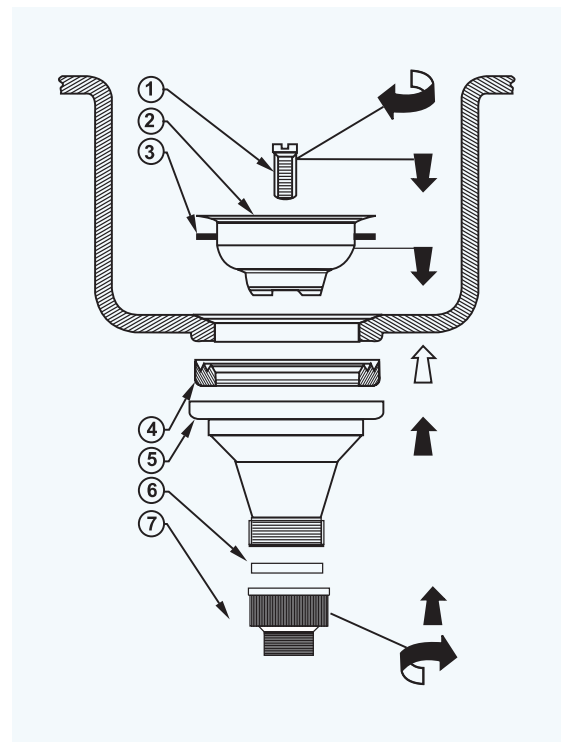

LAY-ON

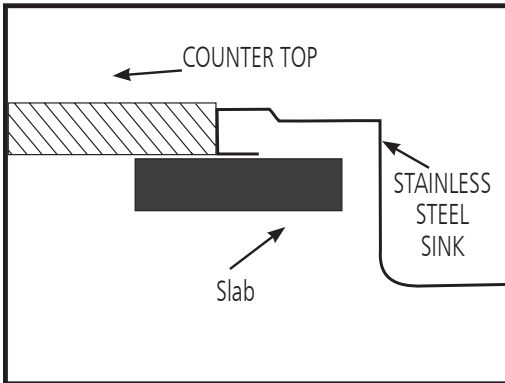

The most conventional method of sink installation in India. The sides of sink are show banded to be in line with Granite / Concrete slab for installation. It gives strength to the sink and is most durable. The sink can be installed in number of ways. It can be placed on ledge created in granite or in concrete slab. It has by for the easiest method of installation.

BEEDED

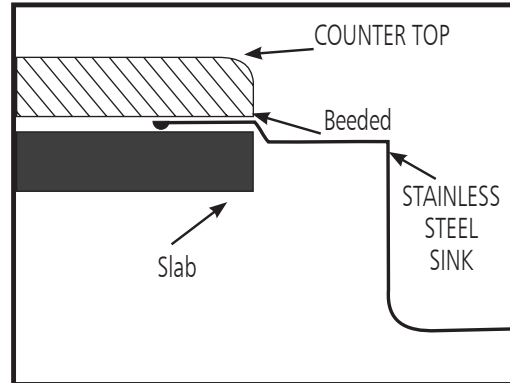

Beeded Profile sink has been developed keeping in mind the growing market of modular kitchens in India and elimination of concrete slabs and use of lower thickness Granite has resulted in development of Beeded sink. The sides of the sink are banded 8 mm inside and pressed together to give strength to the sides for installation, as the sink is sandwiched between Wooden top and Granite . This gives elegant look to the kitchen.

UNDERMOUNT

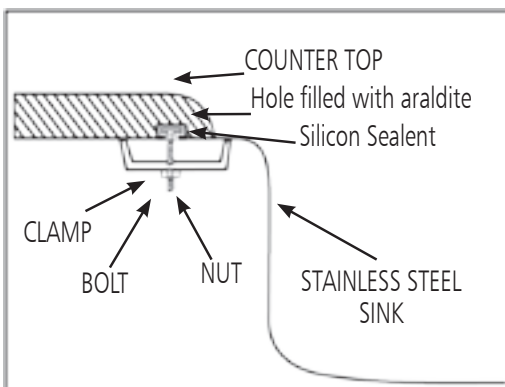

UNDER MOUNT SINKS – are designed to mount beneath your counter surface. They are made in a number of different sizes - both round and oval - to accommodate your installation requirements. Undermounting gives the sink and surrounding area a much sleeker appearance. It prevents dirt from getting trapped around or below the rim and it is absolutely waterproof when installed correctly.

INSET

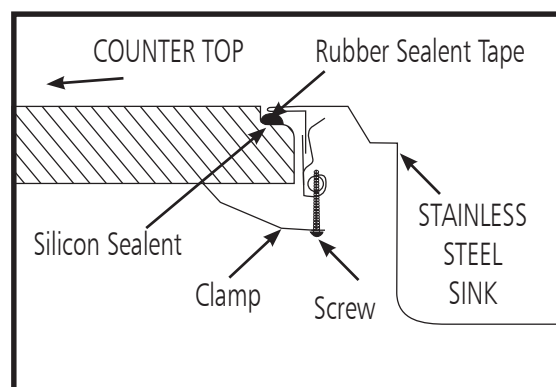

INSET sinks were traditionally of the inset type, that is, with the rim of the sink sitting on the work surface. Our inset sinks can be mounted on virtually any work top using clip and- bolt fasteners, which adjust to the thickness of the surface for a tight, non-slip fit. The sink is fastened to the work top from underneath, so no screws or bolts show.

The inset design has a small rim to stop water spilling onto the work surface. Some inset sinks can also be undermounted using special undermount clips.

INSET Sinks Installation Instructions

Stainless Steel Inset Sinks with Fixed Position Clips.

Caution :

Sink edge may be sharp, handle with caution. Inspect the sink carefully before installation for any damages.

- Place the sink upside down on the counter top. Position the sink relative to the work top as required, ensuring that the cabinet framework will be clear of all parts of the sink.

Draw a line all around the sink with soft lead pencil as shown in the picture



- Remove the sink and draw another line 7 mm inside the outline of the sink top. This is cutting line for the counter top.

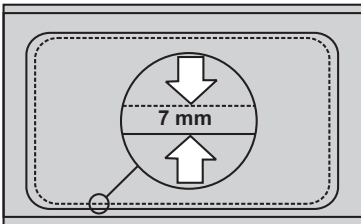

- Make a ledge on the counter top from the original line as shown in the picture.

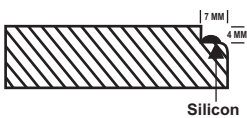

- Put silicon sealant all around on the ledge.

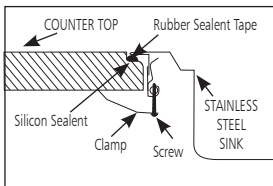

INSTALLATION LAYOUT DIAGRAM IN-SET SERIES

- Put Rubber sealant tape underneath the sink flange.
- Place sink on the ledge.
- Tighten the fixing clip from underneath.
- Clear the extra silicon sealant from the sink counter top.
- Tighten the Fixing Screws. Do not over tight the fixing clamps once the sink is fully bedded in the sealing tape. Do not tighten fully at the first attempt.

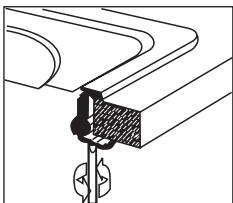

- Leave it dry for six hours before use.
- Your Inset sink is ready for use.

Hint : After Silicon cures, wipe inside edge with denatured alcohol. This will smooth out any rough areas.

UNDERMOUNT Sinks Installation Instructions

This sink is designed to be under mounted in solid surface counter top only.

Caution :

Sink edge may be sharp, handle with caution. Inspect the sink carefully before installation for any damages.

- Cut out the counter top using the template provide.
- Determine placement of clip brackets and make holes of 10mm round and 10mm deep in reverse side of counter Top 32mm away from the bore all around on every 8" to 10" gap.
- Fill the Holes with the araldite.
- Place the bolt heads in the holes made in the counter top.
- Leave the Counter Top for 24 Hours to get dried up.
- Fix the counter top on the cab net.
- Position and align sink under opening of the counter top.
- Position brackets on the bolt and fix the nuts. Ensure that sink should be 8-10mm away from the counter top.
- Apply a bead of silicon evenly along the edge on the sink all around.
- After re-checking alignment, tighten clip brackets against sink edge.
- Remove excess Silicon.

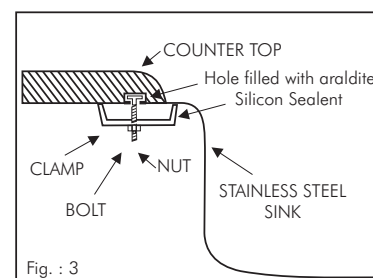
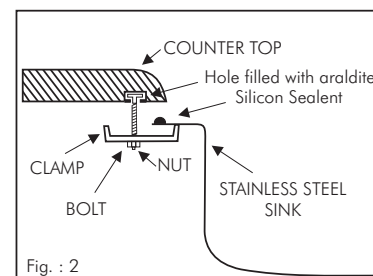
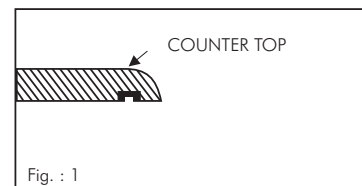

Note :

This template is only a guide; actual sink should be present to ensure perfect cut out.

Hint : After Silicon cures, wipe inside edge with denatured Alcohol. This will smooth out any rough areas.

Lay-on Sink Installation Instructions

This Sink is designed to install on solid surface, these sinks are having border thickness of 16 mm it is ideal if install flush with granite

Caution :

Sink edge may be sharp, handle with caution. Inspect the sink carefully before installation for any damages.

- Place the sink up-side down on counter top/granite position the sink relatively to the work top as required, insure that the cabinet frame work / concrete slab will be clear of all parts of sink.

Draw a line all around the sink with soft lead pencil as shown in the picture.

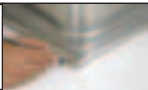

- Remove the sink this is cutting line for counter top.
- Cut the counter top.
- Bore in Concrete slab should be 25 mm extra all around the sink bowl.
- Put the silicon sealant / white cement on concrete edge.

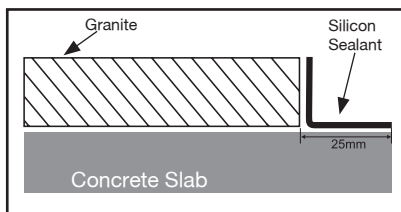

- Place the sink on edges of concrete slab through counter top / Granite slab.

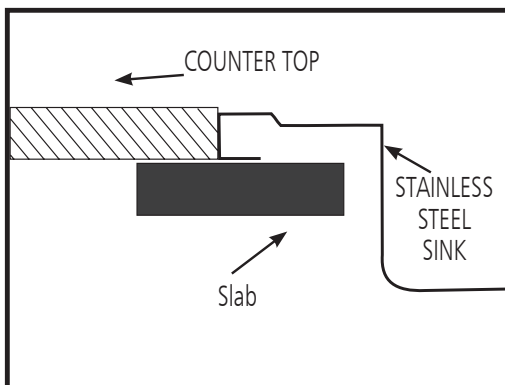

- If any gap between edge of sink and counter top / Granite, it can be filled by silicon sealant / white cement.
- Clear the extra sealant / white cement from the sink Counter top / Granite slab.
- Leave it dry for 12 hours before use.

Beeded Sink Installation Instructions

This Sink is designed to installed as sandwich position between granite slab & concrete slab / wooden frame.

Caution :

Sink edge may be sharp, handle with caution. Inspect the sink carefully before installation for any damages.

- Place the sink up-side down on counter top/granite, position the sink relatively to the work top as required, insure that the cabinet frame / concrete slab shall be clear of all parts of sink.

Draw a line all around the sink with soft lead pencil as shown in the picture



- Remove the sink and draw another line of 12mm inside the outline of sink top. This is cutting line for counter top/granite slab.

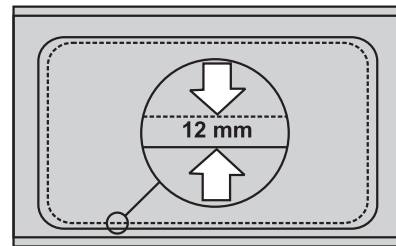

- Cut the counter top and granite slab.
- Create a bore off 18 mm extra all around the sink bowl in Concrete slab / wooden frame.
- Put the silicon sealant / Araldite on concrete edge / wooden frame.
- Place the sink on concrete slab / wooden frame.
- Put the silicon sealant / Araldite on top of sink edge 10mm all around.

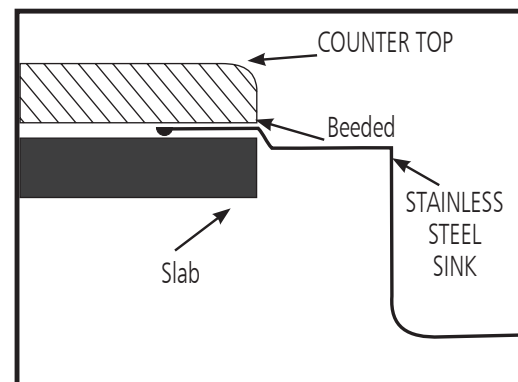

- Place the Granite on the sink by keeping equal distance from all around edge of sink.
- Ensure that sinks is properly sandwiched between Counter top / Granite slab and concrete slab / wooden frame.
- Leave it dry for 12 hours before use.

25 Years Limited Warranty

Warranty

Neelkanth sinks are warranty for free replacement against any major manufacturing defect. However transportation & installation costs (counter top) are excluded, the warranty is only for sink. Eligibility of replacement shall be the sole discretion of manufacturer.

This warranty does not apply to defect or damage caused by:

- Failure to follow the recommended procedures for installation, care and maintenance.
- Tarnish and discoloration.
- Dents or scratches.

This warranty applies only to sinks:

- Used only in residential application.
- Which fail due to manufacturing defect.
- Which have not been moved from original installation location.

To Obtain Service Under Warranty

- **Include a letter containing the following information:**
 - a) Date of purchase and installation.
 - b) Description of nature of defect.
 - c) Model number or description of model and/or component part if possible.
 - d) The support of invoice / bill.

Warranty Exclusions:

Excluded are any accessories that accompany the sink (strainers, waste fittings, waste pipe etc.).

Term & Conditions:

1. All sizes are approximate \pm 5mm rounded off.
2. Due to continues research & development to improve the products, sizes & other specification can change without any prior notice.

MAINTENANCE AND CARE

Do's

Stainless steel sinks are easy to keep clean. Simple everyday maintenance, as outlined below, will ensure its long-lasting beauty.

DO... Daily regular cleaning to remove dirt and prevent staining is recommended. For this purpose liquid dish detergent, water and a soft household sponge or cloth is recommended.

DO... Rinse thoroughly after each use. "Thorough rinsing can be done by running water for a few minutes and rubbing the cleaned area with a clean sponge.

DO... Towel dry after each use to prevent mineral deposits from building up on the surface of the sink.

DO... Mild, non-abrasive cleaners can be used with a nylon scrub pad. For stainless steel sinks, rub with the grain of the finish and rub the entire sink surface to obtain a uniform appearance. Rinse with water and wipe down sink with a soft, dry cloth. Drying the sink will prevent water spots caused by lime in the water.

DO... Stubborn stains from hard water's salt particles deposits can be removed by pouring a little warm vinegar based cleaner into the sink and allow it to sit for a few minutes. Rinse with clean water and dry.

DO... To clean the three way matt finish used 3 M scotch bright the direction of surface hair line.

Don't

DO NOT... Use a steel wool pad to clean your sink. Steel wool pads have a tendency to break apart and small particles of steel can become embedded in the surface of the sink. The steel particles will rust and will give the appearance that the sink itself is rusting.

DO NOT... Allow soap or other household cleansers to dry on surface of the sink. Most brands contain chemical additives which will affect the original finish.

DO NOT... leave rubber or plastic protective mats in the sink. The contact points where the mat rests on the sink tend to collect residue which may leave marks on the sink and can result in unsanitary areas.

DO NOT... Exposed Residential stainless steel sinks to the following agents. If contact should occur, rinse immediately with clean water and clean the sink thoroughly.

- Photographic chemicals, particularly those containing ferric chloride.
- Iodine
- Chlorine bleach. Chlorides will attack the protective layer of the sink. Always dilute if used for disinfection.
- Acids, such as sulfuric and hydrochloric in high concentrations.

The concentration of acids contained in drain cleaning products is low; however, thoroughly rinse the sink bowl if those products are used. The best method of "preventive maintenance" is to ensure that the sink is dry and clean when not in use.



Distributor / Dealer

Manufactured by:
Tii Tropical Industries International (P) Ltd.

Plot No. 31, Sector 57, HSIIDC Phase IV, Kundli, Sonapat, Haryana
Mobile no.: +91-7838596200

e-mail: neelkanth@neelkanthsinks.com
[www. neelkanthsinks.com](http://www.neelkanthsinks.com)